

AD-A218 911

Contract No. DAAL03-88-C-0024

DTIC FILE COPY

2

FINAL REPORT:

On-Line X-Ray Inspection of Materials and Structural Components Using Discrete Element X-Ray Detectors for Digital Radiographic and Computed Tomographic Evaluation

Submitted by:

BIO-IMAGING RESEARCH, INC.
425 Barclay Blvd.
Lincolnshire, IL 60069
(708) 634-6425

DTIC
ELECTE
MAR 07 1990
S D CS D

For the:

DEPARTMENT OF THE ARMY
United States Army Laboratory Command
Army Research Office

Period of Performance:

August 1, 1988 to January 31, 1990

DISTRIBUTION STATEMENT A
Approved for public release
Distribution Unlimited

Principal Investigator



Bruce G. Isaacson, Product Manager

90 03 06 043

REPORT DOCUMENTATION PAGE

1a. REPORT SECURITY CLASSIFICATION Unclassified		1b. RESTRICTIVE MARKINGS	
2a. SECURITY CLASSIFICATION AUTHORITY		3. DISTRIBUTION / AVAILABILITY OF REPORT Approved for public release; distribution unlimited.	
2b. DECLASSIFICATION / DOWNGRADING SCHEDULE			
4. PERFORMING ORGANIZATION REPORT NUMBER(S)		5. MONITORING ORGANIZATION REPORT NUMBER(S) ARO 25952.1-EG-SBI	
6a. NAME OF PERFORMING ORGANIZATION Bio-Imaging Research, Inc	6b. OFFICE SYMBOL (If applicable)	7a. NAME OF MONITORING ORGANIZATION U. S. Army Research Office	
6c. ADDRESS (City, State, and ZIP Code) 425 Barclay Blvd. Lincolnshire, IL 60069		7b. ADDRESS (City, State, and ZIP Code) P. O. Box 12211 Research Triangle Park, NC 27709-2211	
8a. NAME OF FUNDING / SPONSORING ORGANIZATION U. S. Army Research Office	8b. OFFICE SYMBOL (If applicable)	9. PROCUREMENT INSTRUMENT IDENTIFICATION NUMBER DAAL03-88-C-0024	
8c. ADDRESS (City, State, and ZIP Code) P. O. Box 12211 Research Triangle Park, NC 27709-2211		10. SOURCE OF FUNDING NUMBERS	
		PROGRAM ELEMENT NO.	PROJECT NO.
11. TITLE (Include Security Classification) On-Line X-Ray Inspection of Materials and Structural Components Using Discrete Element X-Ray Detectors for Digital Radiographic and Computed Tomographic Evaluation			
12. PERSONAL AUTHOR(S) Bruce G. Isaacson			
13a. TYPE OF REPORT Final	13b. TIME COVERED FROM 8/1/88 TO 1/31/90	14. DATE OF REPORT (Year, Month, Day) Feb 1990	15. PAGE COUNT 54
16. SUPPLEMENTARY NOTATION The view, opinions and/or findings contained in this report are those of the author(s) and should not be construed as an official Department of the Army position, policy, or decision, unless so designated by other documentation.			
17. COSATI CODES		18. SUBJECT TERMS (Continue on reverse if necessary and identify by block number)	
FIELD	GROUP	X-Ray Inspection, Radiography, Material Evaluation, Discrete Element Detectors, Computed Tomography, Tomography, Digital Radiography, Composite Materials.	
19. ABSTRACT (Continue on reverse if necessary and identify by block number)			
<p>→ epoxy matrix, glass cloth with polyester matrix, alvar cloth polyimide/buteral matrix</p> <p>This project was designed to study the effectiveness of industrial computed tomography (CT) and digital radiography (DR) as inspection techniques for the evaluation of materials and structural components manufactured on-line. The results indicate that CT is an appropriate technique if speed and cost are not critical considerations. Digital radiography is the faster technique, but provides less information about the material. Limited view tomography (LVT), which is a simplified form of computed tomography, was compared and found to provide a good compromise between CT and DR when a priori knowledge of material structure is available. For some material configurations, it provides virtually complete CT data in a fraction of the time required for full view CT data collection and reconstruction. It offers the greatest potential for the productive cross-sectional characterization of composite materials.</p> <p>→ computed tomography → digital radiography</p>			
20. DISTRIBUTION / AVAILABILITY OF ABSTRACT <input type="checkbox"/> UNCLASSIFIED/UNLIMITED <input type="checkbox"/> SAME AS RPT. <input type="checkbox"/> DTIC USERS		21. ABSTRACT SECURITY CLASSIFICATION Unclassified	
22a. NAME OF RESPONSIBLE INDIVIDUAL		22b. TELEPHONE (Include Area Code)	22c. OFFICE SYMBOL

CONTENTS

1.0 PROGRAM SUMMARY.....1

2.0 Program Objectives.....2

3.0 Technical Background.....3

 3.1 Digital Radiography.....3

 3.2 Computed Tomography.....4

 3.3 Limited View Tomography.....6

 3.4 X-Ray Detectors.....7

 References.....15

4.0 Experimental Setup.....10

5.0 Materials Evaluation.....12

 5.1 Armor.....12

 5.2 Helmets.....23

 5.3 Pultrusion Samples.....35

6.0 Conclusions.....48

 6.1 Discussion.....48

 6.2 Proposed Inspection System Based on Phase I Results.....49



Accession for	
NTIS ORAD	<input checked="" type="checkbox"/>
DTIC TAB	<input type="checkbox"/>
Unannounced	<input type="checkbox"/>
Justification	
By	
Distribution	
Availability Codes	
Dist	Availability of Statement
A-1	

1.0 PROGRAM SUMMARY

This project was designed to study the effectiveness of industrial computed tomography (CT) and digital radiography (DR) as inspection techniques for the evaluation of materials and structural components manufactured on-line. The results indicate that CT is an appropriate technique if speed and cost are not critical considerations. Digital radiography is the faster technique, but provides less information about the material. Limited view tomography (LVT), which is a simplified form of computed tomography, was compared and found to provide a good compromise between CT and DR when a priori knowledge of material structure is available. For some material configurations, it provides virtually complete CT data in a fraction of the time required for full view CT data collection and reconstruction. It offers the greatest potential for the productive cross-sectional characterization of composite materials.

Three composite products were evaluated in this study:

- 1) epoxy glass material manufactured by pultrusion into structural shapes
- 2) glass cloth with polyester matrix manufactured into armor by the autoclave process
- 3) Kevlar cloth polyvinylbutyral matrix manufactured into Army helmets using pressure/heat accelerated curing.

The pultruded material has a random arrangement of glass fiber base material in an epoxy matrix, with little or no consistent orientation of internal features. The glass and Kevlar cloth based materials are both layered construction, with consistent orientation of internal features. This orientation confines the features of interest to the plane parallel to the cloth layers. Such prior knowledge of material structure can be important for efficient application of inspection techniques. Also, a material configuration where all features of interest lie in parallel planes is an important factor in defining the best inspection method.

The three x-ray inspection methods used to characterize the test samples—CT, DR, and LVT—are all based on discrete detector technology. Of the three techniques, CT provides the most complete cross-sectional data but is generally too slow for the production environment. The detailed images obtained in CT are ideal, however, as the baseline reference to gauge the success of the other two methods investigated in this study.

Digital radiography is a high speed inspection technique amenable to production throughput, but subject to superpositioning of features in the image. Superpositioning of features can make DR images more difficult to interpret than CT images. DR can reveal major structures of the material, but cannot distinguish more subtle features.

Limited view tomography offers a good compromise between the high degree of image detail provided in CT and the fast imaging throughput provided in DR. The success of the technique depends on a priori knowledge of material composition and defect formation. The cross-sectional images obtained in limited view CT are not as detailed as full view CT images, but data can be effectively collected and characterized at production rates by selective sampling.

2.0 PROGRAM OBJECTIVES

The Phase I program was designed to examine and compare radiographic imaging techniques based on discrete detector technology that could be used to evaluate manufacturing process and quality control. Representative material samples were collected and imaged using three x-ray techniques to determine if sample variations could be detected. Each technique was applied using parameters that would fit production rates and provide optimum results. Results were evaluated for the degree and quality of information provided as well as for compatibility with production requirements. Advantages and disadvantages of the three techniques as they apply to a production environment were compared.

Three products of interest to the Army were chosen for study. These products were selected to represent a variety of materials and manufacturing processes. All of the products were composite structures, which represent the greatest technical challenge in terms of nondestructive evaluation (NDE). These materials are challenging because they are complex assemblies of diverse materials. Verification of the integrity of the assembled product is critical to its functionality.

The feasibility of using discrete element x-ray detector technology to inspect composite materials in a manufacturing environment was examined. Discrete detectors are used in the three imaging modalities evaluated in this study:

- and digital radiography (DR)
- computed tomography (CT)
- limited view tomography (LVT).

CT images of the samples were taken and used as baseline data. CT images are appropriate for this purpose because they contain the greatest amount of detail and provide the most information about material structure.

The reliability of each technique was evaluated. This evaluation was based on a comparison of the signal obtained from a feature in the image and the background noise. Standard deviations of 4:1 or better are generally required for reliable feature identification, which is necessary for automated inspection.

BIR's Radapt 2 imaging system was used for data acquisition and image reconstruction. BIR's color image workstation was used for analyzing the reconstructed images.

3.0 TECHNICAL BACKGROUND

Real-time x-ray methods for inspecting the internal structure of materials have been used for many years. Such traditional real-time methods generally consist of an x-ray source with a x-ray image intensifier as the detection device. Images are available in real-time, but have a limited dynamic range as a result of the image intensifier. Consequently, real-time technology is adequate for qualitative evaluation of gross changes in material characteristics, but is not useful for distinguishing very small material variations. Because of these limitations, other techniques based on discrete element detector technology were introduced for industrial applications.

3.1 Digital Radiography

Digital radiography and film radiography are both projection radiographic imaging techniques. In DR, however, the imaging medium is a linear array of discrete solid-state detectors rather than film. A DR image can be generated by simultaneously moving the x-ray source and detectors while attenuation data is collected at regular spatial intervals. The data is then processed by computer and displayed on a screen as a radiographic image. The concept for DR is shown in Figure 1.

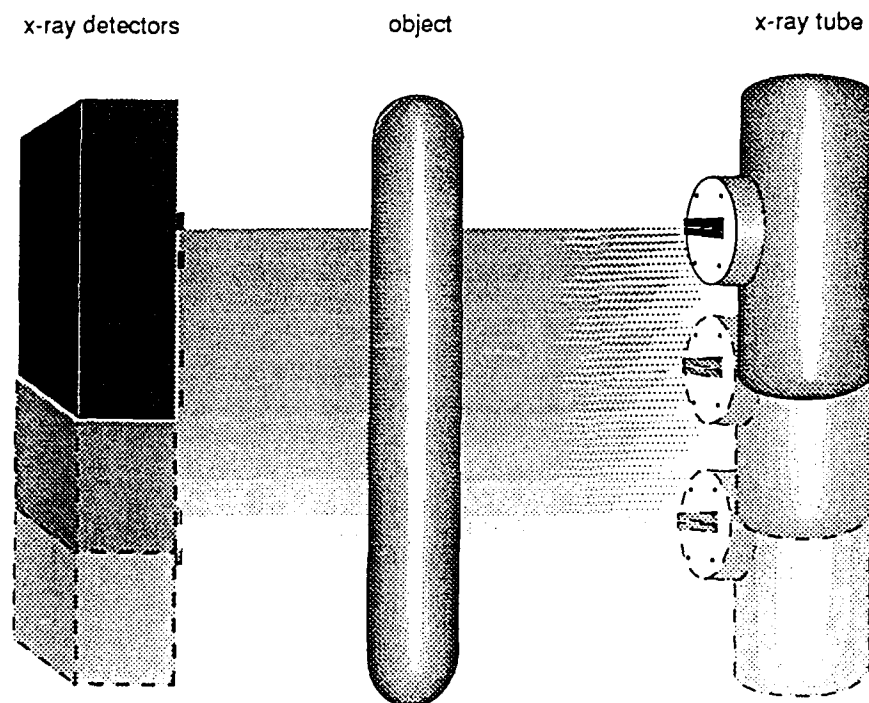

Side View:

In digital radiography, the source and detectors make a synchronous vertical pass along the major axis of the object, or vice versa. Data is collected along the length of the object.

Figure 1. The concept of digital radiography is shown in the drawing.

Digital radiography using *solid-state detectors* can provide contrast sensitivity ten to 100 times better than can be achieved with film radiography. As in film radiography, however, overlaying features of the object will be superimposed in the image. The technique is useful for previewing an object in order to locate where a volume of CT image data should be collected. Preview DR images can help to define orientation and to select slice position for tomographic scanning. If cross-sectional information is necessary, however, digital radiography has condensed the complete cross-sectional data set into a single line projection, which can be difficult to characterize for complex composite assemblies.

Figure 2 is an example of a digital radiographic image of composite armor material. The image shows major features, but does not distinguish subtle density variations from the normal material background pattern.

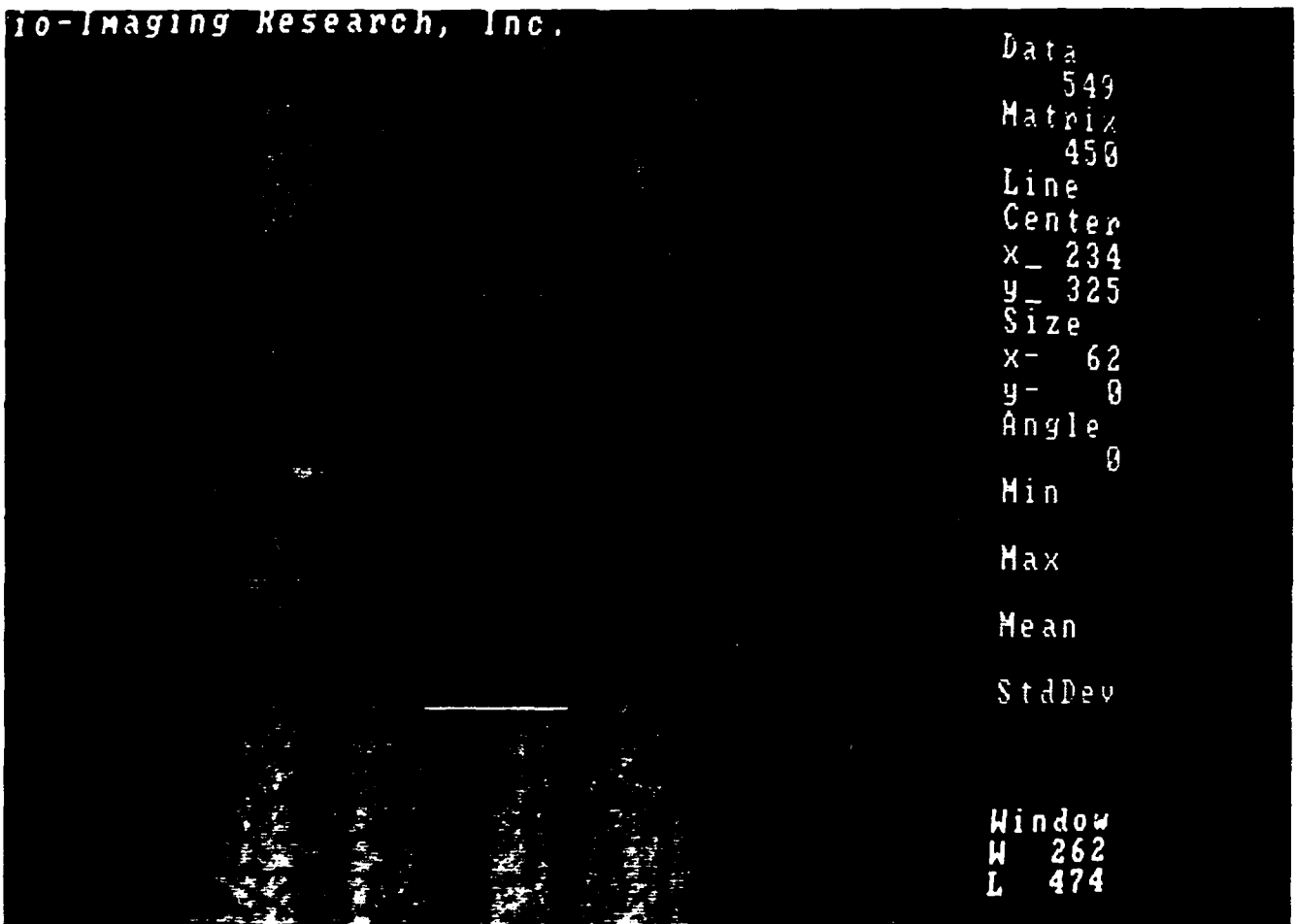

Figure 2. This DR image shows major features in armor composite.

3.2 Computed Tomography

Computed tomography is another radiographic technique that uses a manipulator (scanner gantry), an x-ray source, radiation detectors, a computer system and a display screen. The object to be examined passes through a pencil thin fan beam of x-rays. A mathematically reconstructed image of the cross

section of the object is then displayed on the screen. The mathematics to do this were derived by Radon (1917) and were first practically applied by Bracewell in radio astronomy (1967). Image gray scale (or color scale) represented by individual pixel elements on the screen results in an x-ray attenuation map of the object's cross section. Each image pixel represents an x-ray attenuation coefficient of the object located at a specific depth in the object. In general, the darker the pixel the less dense is that part of the object cross-section.

The first nonresearch application for CT was the EMI Ltd Mark I head scanner invented by Hounsfield (1972). In this first generation scanner, a pencil-thin x-ray beam traversed a patient's head in parallel paths creating x-ray projections through each path. This process was repeated as the beam was rotated through 180°. In other words, data was collected from 180° of views. Later, in second generation CT systems, this "translate-rotate" concept was applied using wider x-ray fans and many detectors for faster scanning. Second generation CT was used in this study.

Figure 3 shows the concept for computed tomography scanning. Note that the object is rotated after each translation through the x-ray source and detectors, and that multiple translations are made to collect at least 180° of data.

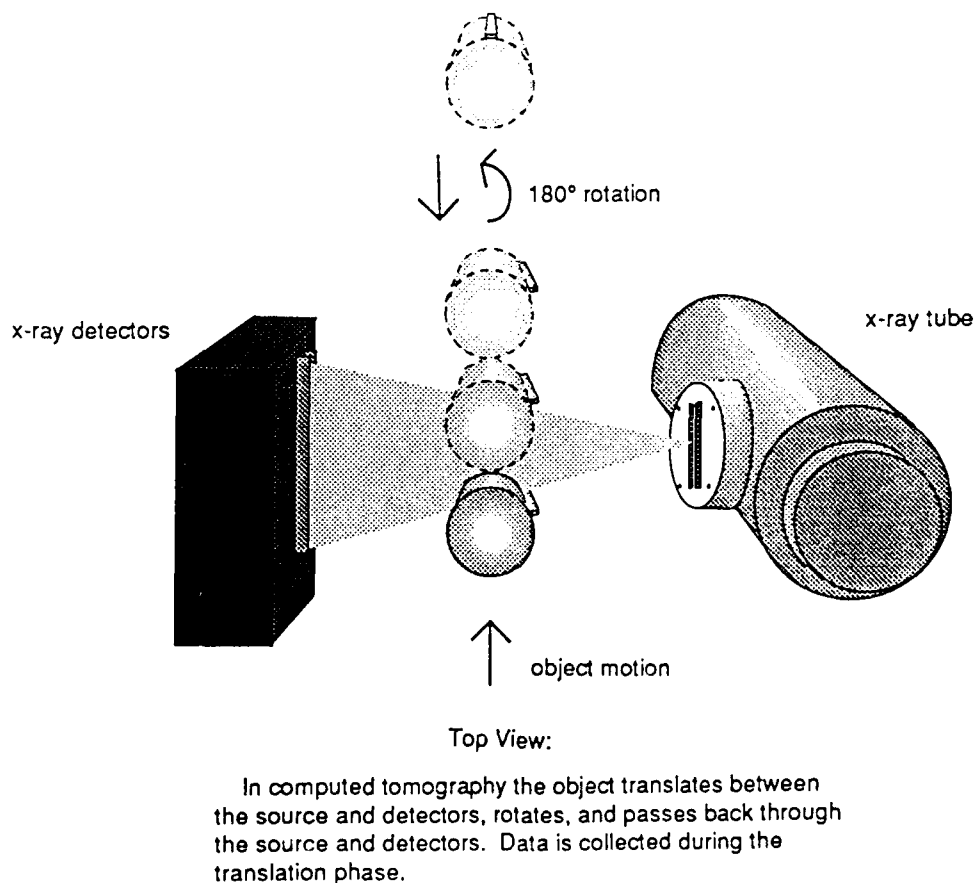

Figure 2. The concept of computed tomography scanning is illustrated.

Figure 4 shows a CT image of composite armor material. The features in the cross section are more distinct than in the DR image shown in Figure 2.

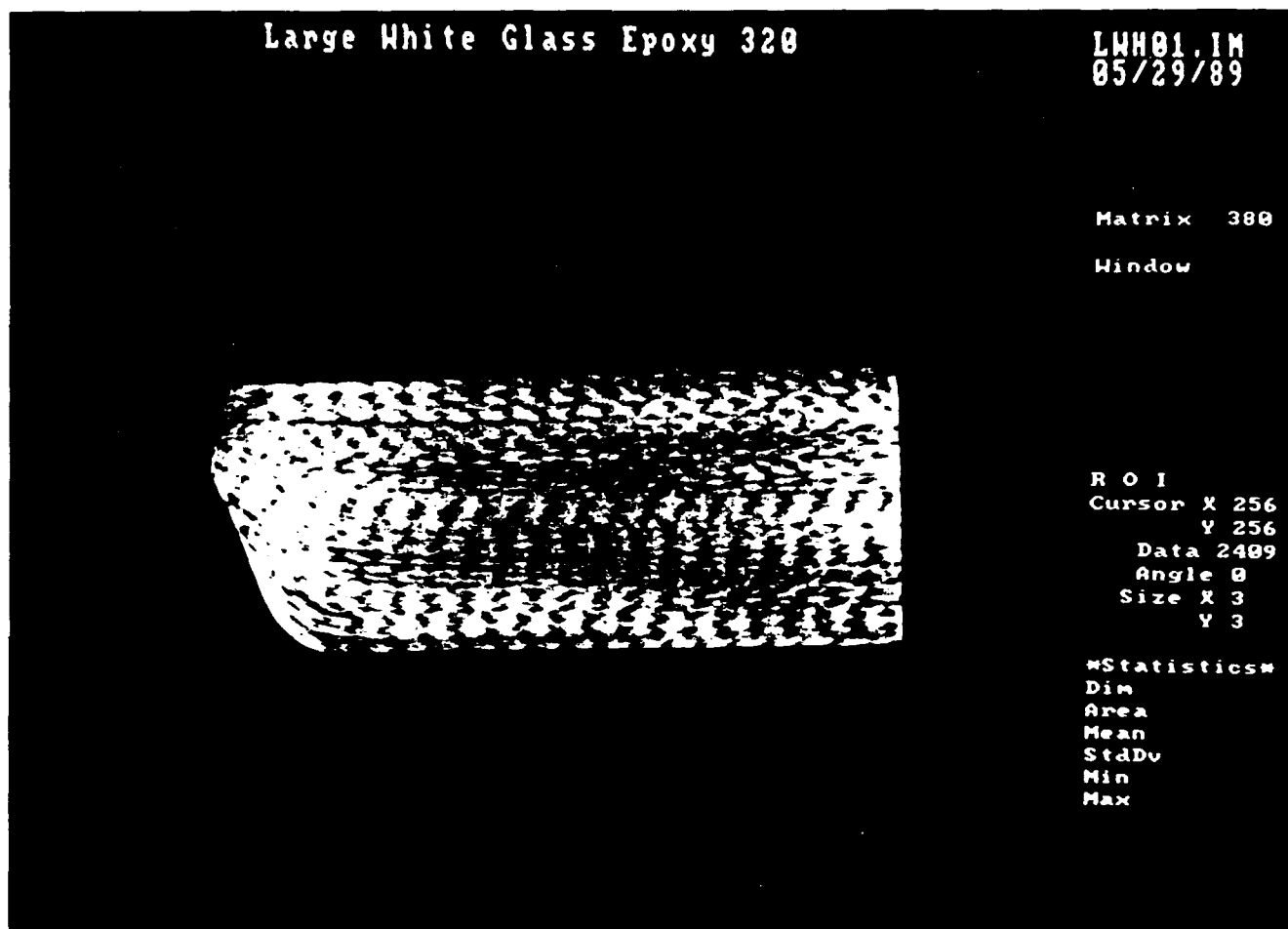

Figure 4. This CT image shows detail in the armor cross section.

3.3 Limited View Tomography

Limited view tomography reconstructs tomographic images from less than 180° of data. In our study, data from 40° was used. Because only a limited data set is collected and processed, limited view CT is faster than conventional CT. Standard convolution and backprojection are used in image reconstruction, but reconstruction is faster than in full view CT as a result of the smaller data set. Therefore, imaging throughput is enhanced again.

LVT images lack the detail normally available in a completely reconstructed CT image. LVT images show the major features within the sample cross section, but do not precisely define their shape and position. For many materials applications, however, this information is sufficient for product evaluation.

Images reconstructed from 40° to 90° have been studied. BIR has extensively investigated the 40° fan angle for limited view tomography because it is the maximum fan angle that can be obtained from a standard directional x-ray tube. This standard x-ray tube, when coupled with a detector array configured for a 40° fan angle, allows data collection from a single translation. This significantly reduces the time and cost of inspection.

Figure 5 shows the concept for limited view tomography system. All of the data is collected in a single translation of the object.

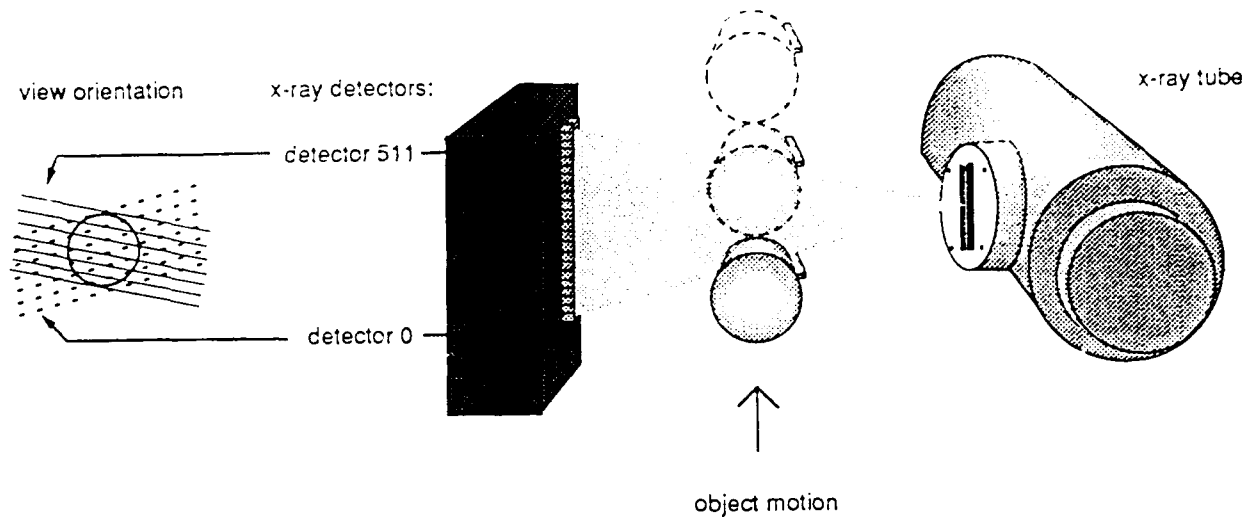

Top View:

In limited view computed tomography the object makes a single translation between the source and detectors. The view from each detector is collected and reconstructed into a cross-sectional image using convolution and backprojection.

Figure 5. The concept of limited view tomography is shown.

3.4 X-Ray Detectors

The history of x-ray detectors reflects the conflict among the imaging requirements for good spatial resolution, high photon efficiency, and low cost. Good spatial resolution demands small detectors. High photon efficiency is a product of two factors: area efficiency determined by how much of the x-ray beam is covered by detectors, and capture efficiency, which depends on the detector material and its depth. These factors imply that the detectors should be as small as possible and cover as much of the x-ray beam as possible in order to collect more photons.

Early detectors used a combination of scintillator crystals and photomultipliers. The scintillators converted x-rays to visible light that was detected in the photomultipliers. Early EMI Ltd detectors of this type used sodium iodide crystals that were about 3 mm wide and gave 0.6 line pairs/mm resolution. Because of their bulk, they were spaced more than 6 mm apart and gave an area efficiency under 50%. Capture efficiency was 85% and total efficiency was near 40%. Later EMI designs used cesium iodide crystals and photodiodes reducing bulk and cost and giving a nearly contiguous array. Capture efficiency was higher and total efficiency reached 78%.

A later detector type was the gas detector, pioneered by G.F. In these detectors xenon gas is dissociated into electrons and ions by x-rays. The electrons and ions are then collected on individual electrodes. Area efficiency is about 80%, but even compressed xenon is not dense enough to capture more than 55% of the x-rays at energies of 100 to 150 kV. Capture efficiency drops to under 15% at 320 kV. Cost per channel is low, however, since a gas detector array is produced as a unit.

Industrial approaches to CT scanning have resulted in new and different detector designs. One industrial scanner uses plastic light-pipe scintillators and photomultipliers, which are excellent for counting photons over long time periods but are low in area efficiency. Other scanners use scintillators made of rare earth powders in a sheet of plastic binder. Light output is detected by a photodiode array or imaging electron intensifier coupled to a TV camera. Here area efficiency is high but capture efficiency is low. All of these techniques are limited either in area efficiency or capture efficiency. The crystal scintillator/photodiode design is the only exception.

The discrete element detectors used in this program are scintillator crystal/photodiode assemblies arranged in a linear array. Cadmium tungstate or cesium iodide are typically chosen as scintillator crystals because of their efficient conversion of x-ray photons to light. These crystals absorb the ionizing radiation from the x-rays and emit it in the form of photons. The photons are converted to electrical signal by the photodiodes, and the signal is then amplified. The scintillating crystal/photodiode detector is used extensively for CT today because it is rugged and can be manufactured at relatively low cost. It also has the high reliability of other solid-state devices.

The wide dynamic range of scintillating crystal/photodiode detectors—that is, their high signal-to-noise ratio—is useful in producing high quality images. A wide dynamic range means that a wide range of material thicknesses can be evaluated at one x-ray exposure. In comparison, traditional filmless x-ray detection media such as image intensifiers or fluorescent screens, are limited in the range of material thicknesses that can be examined in a single exposure. For the traditional media to image the same range in material thickness as discrete detectors, multiple exposures at different operating techniques must be made. This makes these techniques difficult to implement on line.

One final drawback to traditional x-ray detection media is that of signal crosstalk. This undesirable transference of electrical signal causes blooming, or defocusing in areas of brightness in the image. Assemblies of discrete element detectors are separated by a x-ray and light absorbing septa to reduce crosstalk and blooming.

The detector used in this program is shown in Figure 6. The scintillators each have a 250 micron active width on 375 micron centers, providing a spatial resolution of 4 lp/mm at cutoff. The smaller the detector aperture (crystal width), the higher the spatial resolution. BIR has recently designed a detector with a 90 micron scintillator for inspecting porosity in semiconductor ceramic substrates.

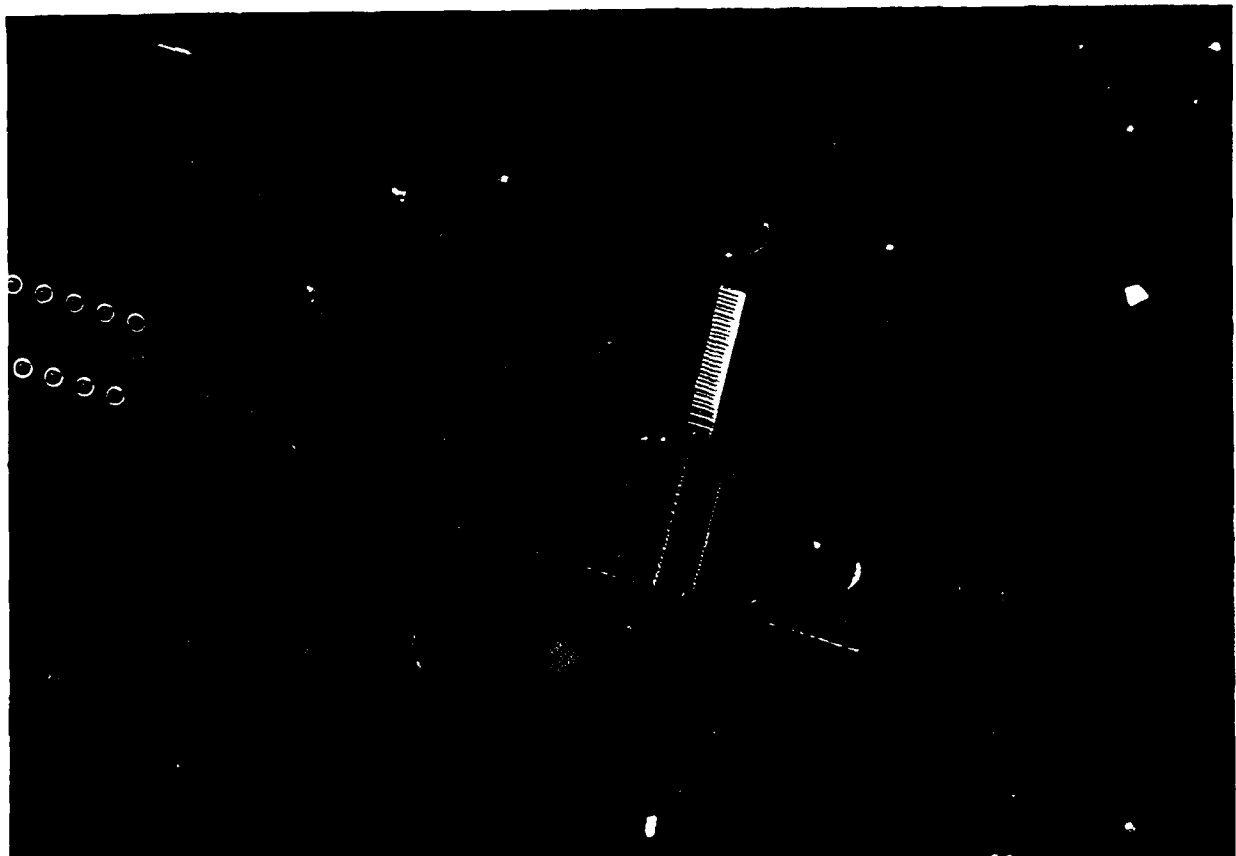

Figure 6. This detector was used in this program. It has 32 channels and can be butted to form large linear arrays.

4.0 Experimental Setup

BIR's Radapt 2 computed tomography inspection system was chosen for these experiments. The system is capable of computed tomography, digital radiography and limited view computed tomography scanning. It has five independent axes, which allow the operator to program a wide range of scan configurations. This flexibility makes it an ideal tool for examining materials under many different conditions.

Radapt 2 is shown in Figure 7. The scanner gantry includes a motorized part manipulation stage that translates, rotates, and moves vertically for CT slice selection. Both the source tower (on the right) and the detector tower (on the left) can be moved independently to vary system geometry. All motions are independently controlled at the computer console. This flexibility means that parts can be inspected with almost any source-to-image distance and source-to-object distance. This flexibility allows us to simulate the conditions of on-line inspection. Although scanning cannot be done at production rates, image processing at production rates can be simulated.

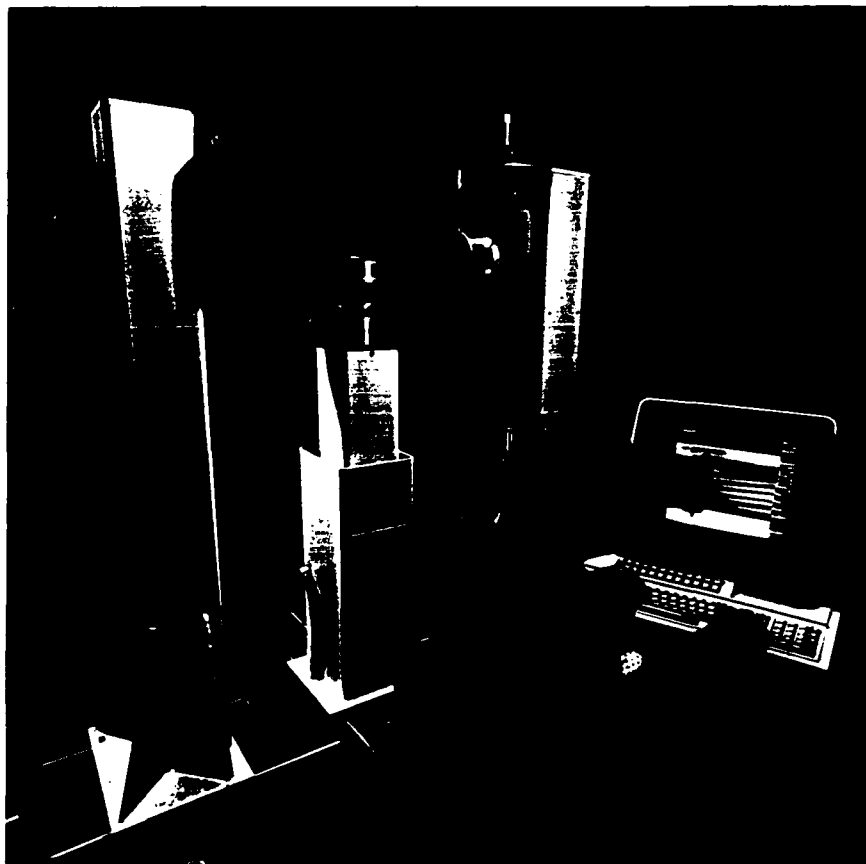

Figure 7. Radapt 2 is the scanner used in this Phase I study. It is capable of full view CT, limited view CT and digital radiography.

Radapt 2 uses the high resolution solid-state detector shown in Figure 6. This 512-channel detector is designed for x-ray energies up to 420 kV, but is sensitive enough to operate satisfactorily at low flux levels as well. The Radapt 2 detector combined with a 0.8 mm focal spot 320 kV x-ray tube can provide 4 line pairs/mm spatial resolution at cutoff for both computed tomography and digital radiography. The detector provides 16 bit gray level data to the computer system, and this 16 bit accuracy is maintained through image reconstruction. The 512-channel linear array enables the system to collect 512 discrete views with a single pass. These views are spread over 20° in Radapt 2, however, the angle is limited only by the x-ray tube fan angle. This situation is analogous to placing 512 cameras adjacent to one another and simultaneously taking a picture, which is much more efficient than using a single camera to take pictures from 512 different angles.

The control console, shown in the lower right corner of Figure 7, is the primary user interface to the scanner. It consists of two monitors, a control panel, a keyboard, and a mouse. The console controls and manages all system resources and provides communication with subsystems such as the data acquisition system (DAS). From the console, the user can create, retrieve, and store files, set scan parameters, initiate scanning, and control the display and analysis of images. The system computer is a Multibus® based single board 68000 CPU. A Mercury ZIP array processor is used for intensive image processing techniques such as CT reconstruction and image filtering. CT reconstruction uses the 16 bit raw data as input to reconstruct a 12 bit image.

Radiographic Technique

The system was configured for CT as follows:

- 320 kV tube
- 0.8 mm focal spot
- source to image distance of 455 mm
- source to object distance of 350 mm.

Second generation (translate-rotate) computed tomography was used in this study. (See Section 3.2.) A series of samples was collected as the object moved past the detectors, from detector 0 to detector 511 (since the detector array consisted of 512 detectors). When the object finished the first translation, it was rotated 20° and moved back through the detector array. A second series of samples was acquired. This translate-rotate sequence was repeated nine times in order to collect samples from 180°. The unreconstructed data set consisting of all views from all nine passes (180°) is considered raw data and is called a *sinogram*. This data set was reconstructed into a detailed cross-sectional image of the object using convolution and back projection.

Dual Energy Technique

Contrast in CT results from the differences in the linear attenuation coefficients of the imaged materials. However, the linear attenuation coefficient of a material has a nonlinear functional dependence upon the energy of the incident X ray. In addition, most commercial x-ray sources emit a distribution of energies. Thus, in a conventional CT image, contrast depends upon the mean energy of the x-ray distribution, and nonlinear artifacts result from the combination of energy dependencies. If only two materials are imaged, data obtained by using two distinct x-ray distributions can be processed to determine the amount of each materials present. This information can be used to produce an artifact free image at some average energy, or to produce separate images of each material. The resources available to the Phase I project were insufficient to support this effort and it will be implemented as part of Phase II. In Phase I, we have taken advantage of the contrast differential between the images obtained using two different energy distributions and have subtracted the images to enhance this difference.

5.0 Materials Evaluation

5.1 Armor

Glass/polyester armor is manufactured into the hull of vehicles or into other large area structures. Present inspection techniques include standard radiography and ultrasound. These techniques have not been able to satisfactorily characterize the cross-sectional structure.

We were supplied small samples, which were convenient for full view (180°) computed tomography scans. The true application, however, requires the cross-sectional investigation of large, unbounded structures. This is a difficult, if not impossible, application for full view CT because it is impossible to collect many of the required views due to the physical structure of the material.

A range of samples were scanned:

- Large Scrap End Sample 1-5/8 inch thick
- Small Scrap Piece 7/8 inch thick
- Number Two Test Sample with 22 plies total (20 prepreg and two S-glass)
- Number Five Test Sample with 69 plies total (61 prepreg and eight S-glass)
- Number Seven Test Sample with 69 plies total (65 prepreg and four S-glass)

The samples were mounted on the Radapt 2 gantry as shown in Figure 8.

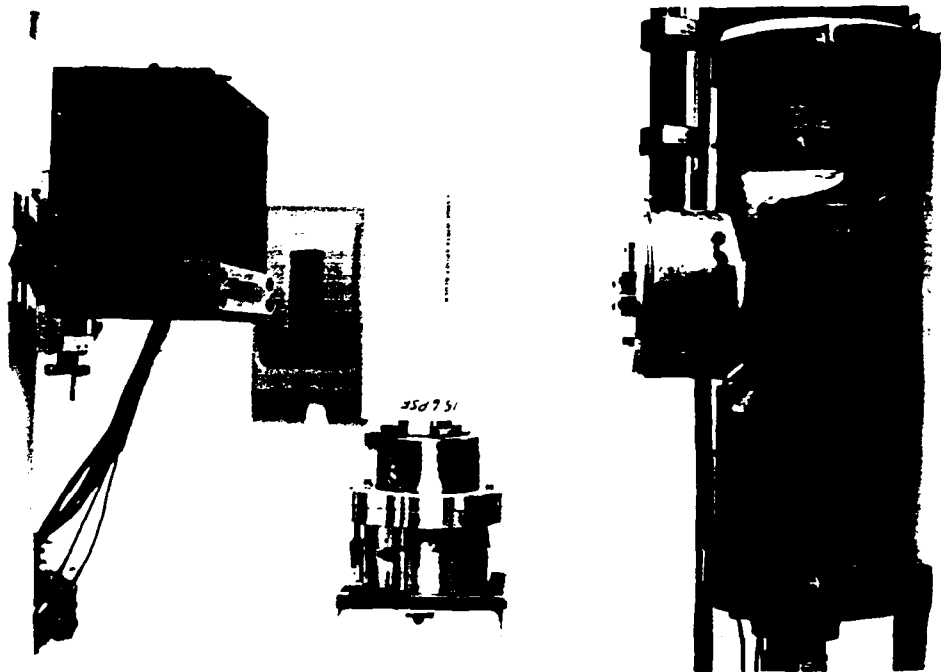

Figure 8. Samples were mounted on Radapt 2 as shown for the Phase I experiments.

A photo of the Large Scrap Piece is shown in Figure 9. A detailed description of each experiment follows.

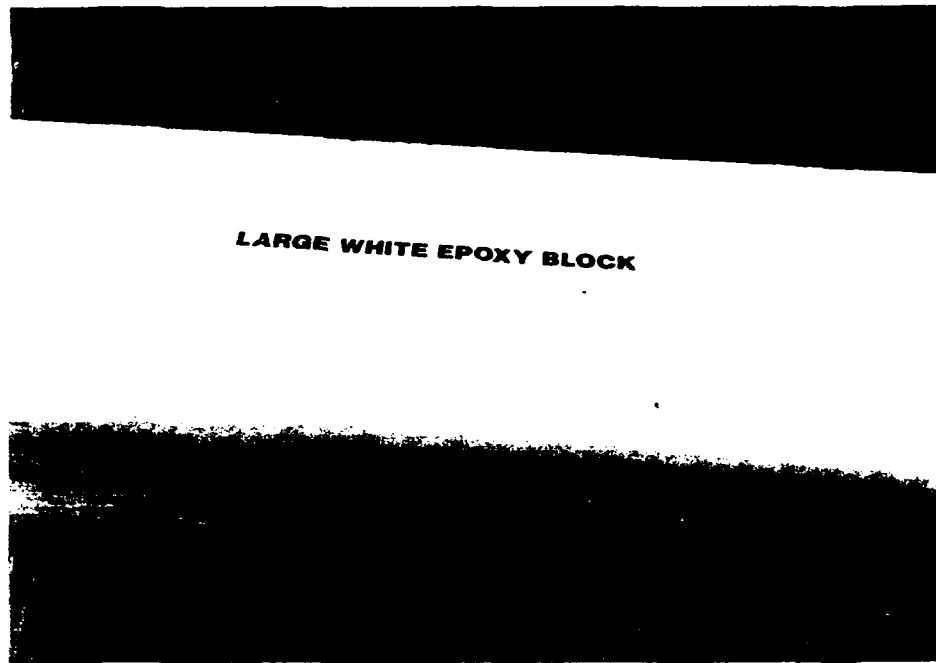

Figure 9. The Large Scrap End Sample is shown in the photo.

Large Scrap End Sample

DR Data—was taken at 320 kV, 1.5 mA. Digital radiographic data collection and reconstruction was completed using an integration time of 50 milliseconds for a 0.25 millimeter sample. This equates to approximately 300 mm/minute, or approximately 12 inches/minute. A sample digital radiographic image is pictured in Figure 2.

Full View CT Data—was taken with a data collect of five minutes and a reconstruction time of approximately five minutes. Data collect time is controlled by the photon requirements of the image and would be difficult to reduce. Image reconstruction time, however, could be decreased significantly with high speed computer hardware. A sample reconstruction is pictured in Figure 4.

Limited View CT Data—was collected over 40°.

Dual Energy Data—was taken at 200 kV, 1.5 mA; the 320 kV data was also reconstructed using dual energy techniques.

Small Scrap Sample

DR Data—was taken at 320 kV, 1.5 mA. The data lacked the information necessary for meaningful evaluation.

Full View CT Data—results were similar to those shown in Figures 10 and 11.

Dual Energy Data—was taken at 150 kV, 1.5 mA. Complete reconstructions were made of this data set providing a detailed cross-sectional image as shown in Figure 10.

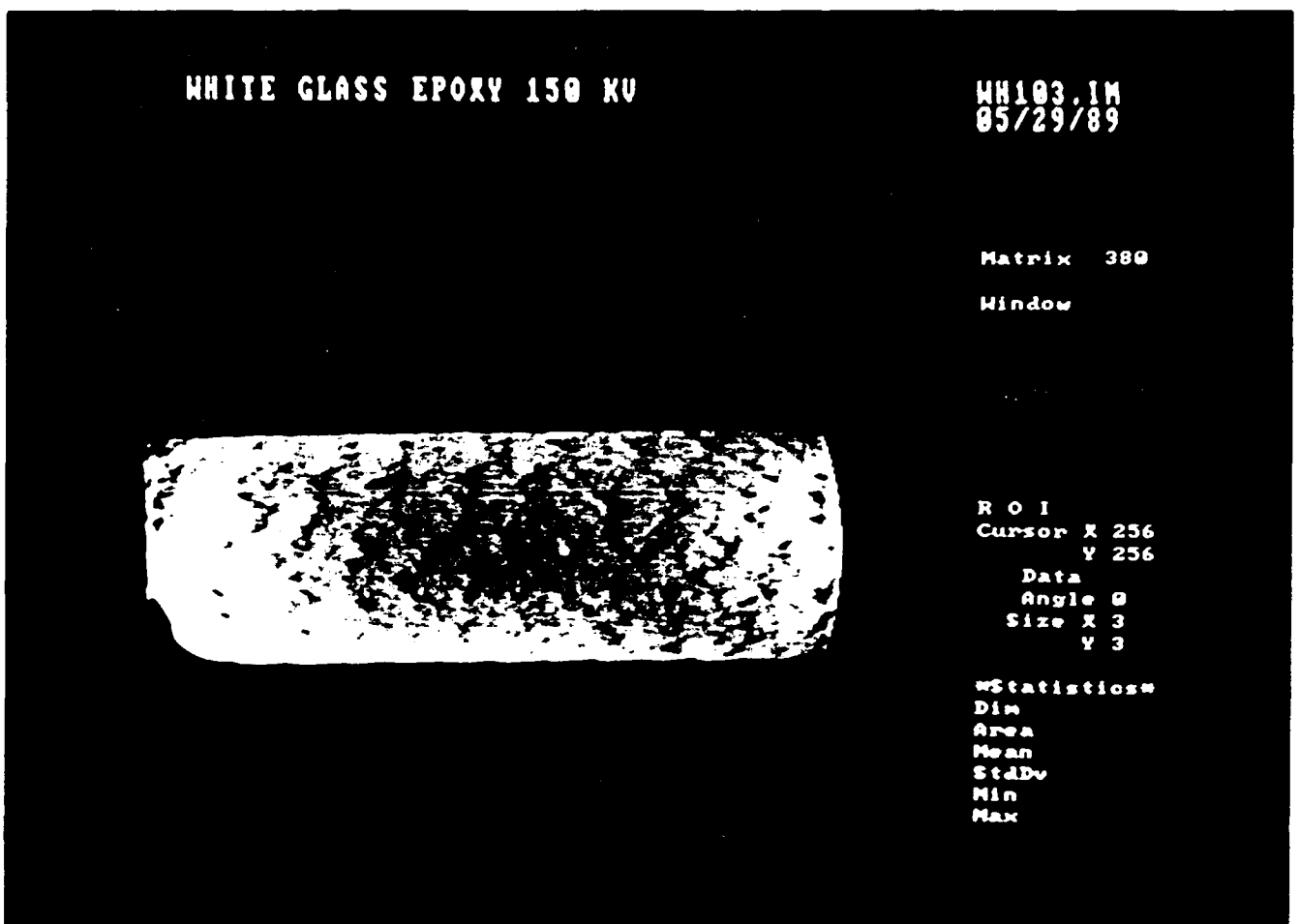

Figure 10. This CT image of the small armor scrap sample shows matrix rich areas (dark spots).

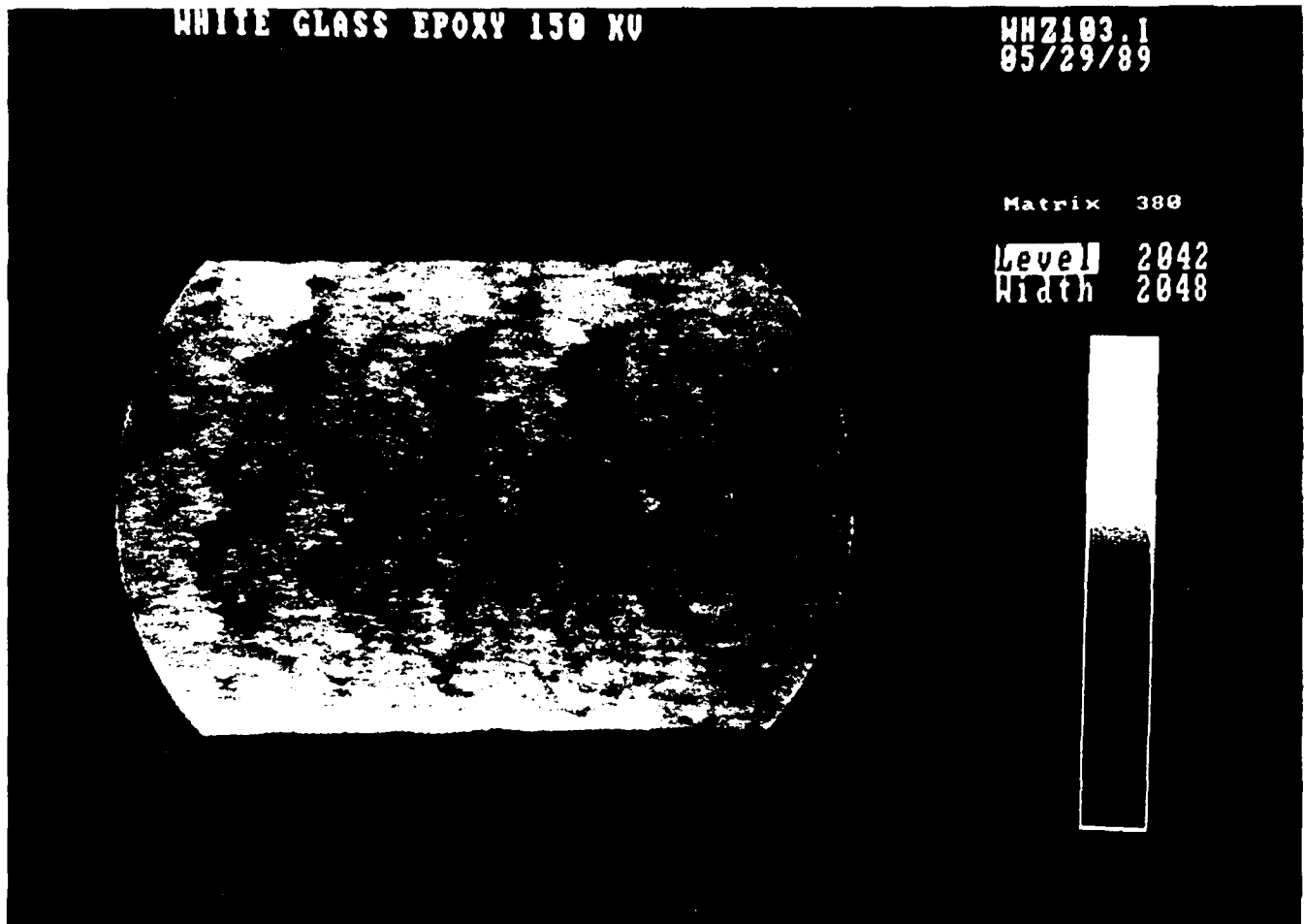

Figure 11. This is a zoom reconstruction of Figure 10. It is a new image reconstructed over a smaller field, which results in magnification.

Number Two Test Sample

Full View CT Data—was collected 320 kV, 1.5 mA. The raw data set is pictured in Figure 12. The reconstructed image is shown in Figure 13 and reveals the low density, matrix rich areas that were seen in all of the full view reconstructions of this material. It also indicates the presence of the higher density S2 glass layers as broken white lines in the image.

Limited View CT Data—indicated the presence of low density features within the part, but the high density S2 glass layers could not be seen. This was true of both a 40° and a 90° reconstruction.

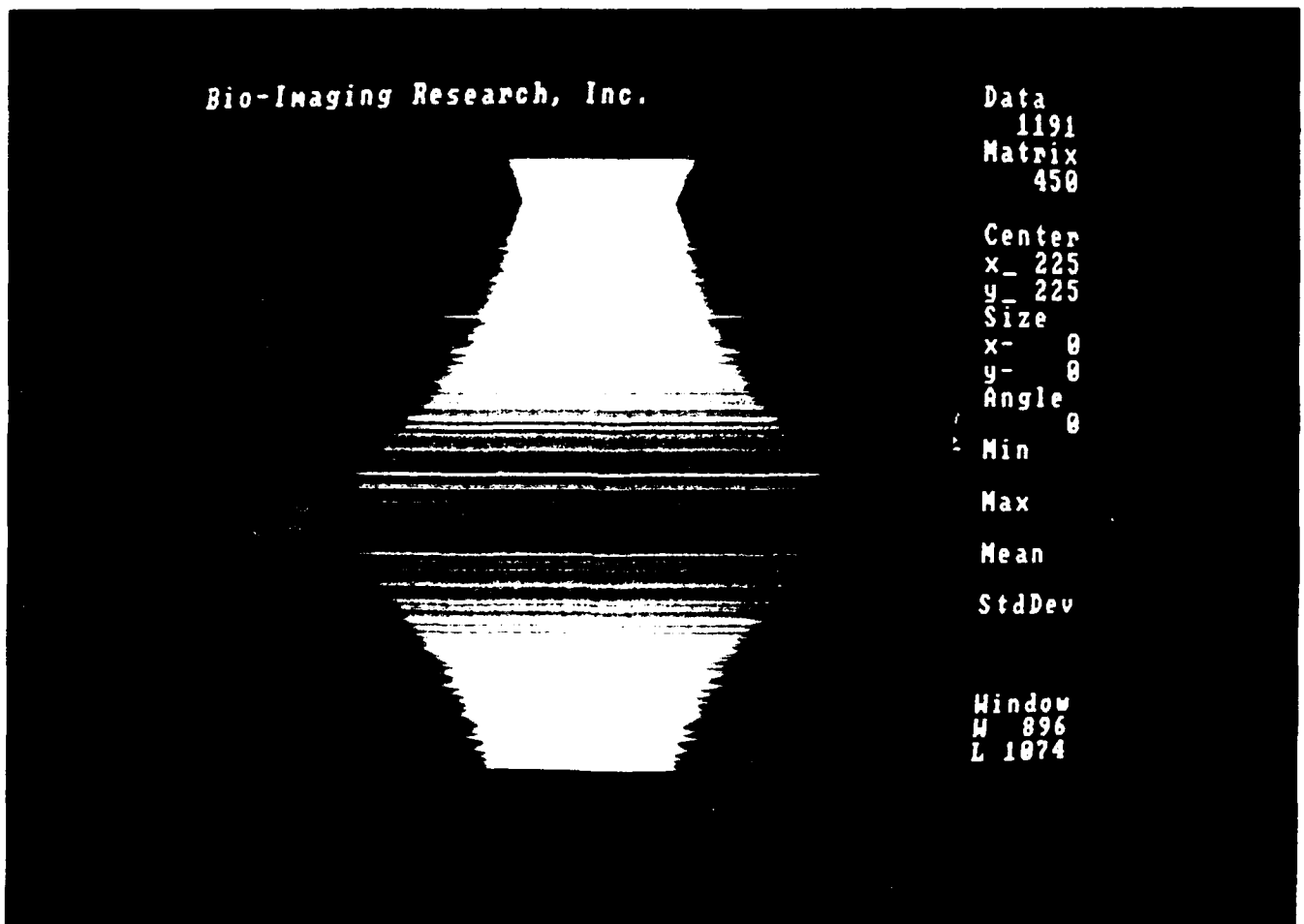

Figure 12. This is a sinogram of the Number Two Test Sample. This data set was used for full view reconstructions as well as simulated limited view reconstruction.

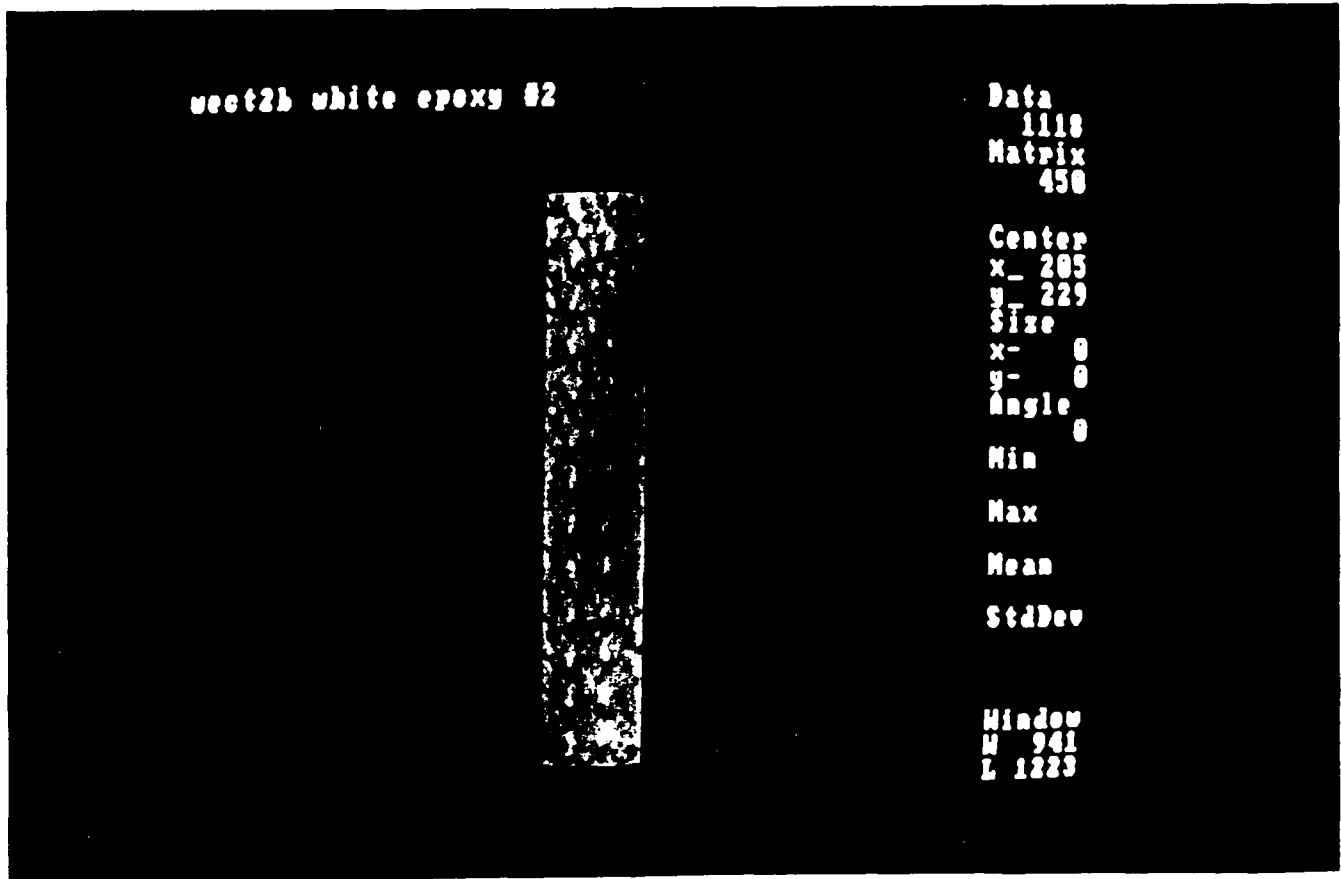

Figure 13. This full view reconstruction of the Number Two Test Sample shows the S2 glass layers.

Number Five Test Sample

The Number Five Test Sample is shown in Figure 14.

Full View CT Data—was taken at 320 kV, 1.5 mA. The reconstruction is shown in Figure 15.

Limited View CT Data—was collected over 40°. It is pictured in Figure 16. The low density features are elongated in the image and would be easy to detect. A 90 degree reconstruction, pictured in Figure 17, begins to detail the low density features more precisely. This could be useful if positional accuracy becomes important. Neither of the limited view reconstructions were able to bring out the high density S2 glass layers in the part.

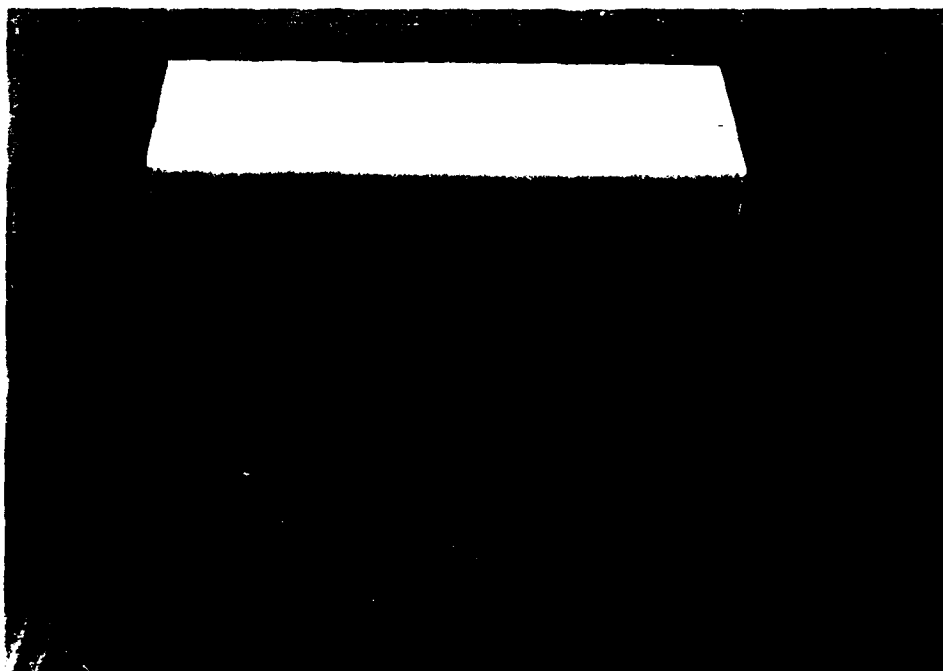

Figure 14. The Number Five Test Sample is shown. It is comprised of eight S2 layer, with a total of 69 plies.

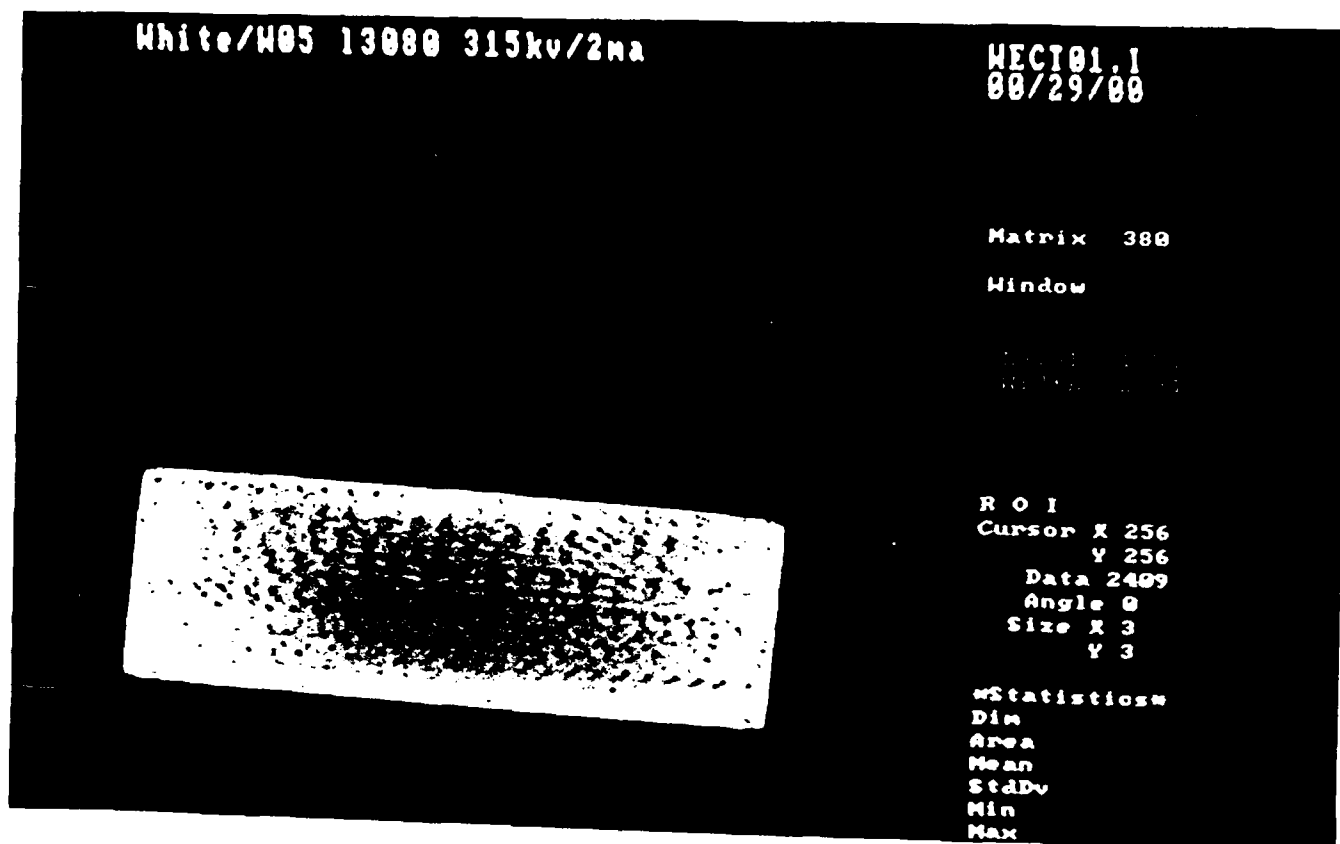

Figure 15. This is full view CT reconstruction of Number Five Test Sample. The eight S2 layers are visible along with the dark matrix rich areas.

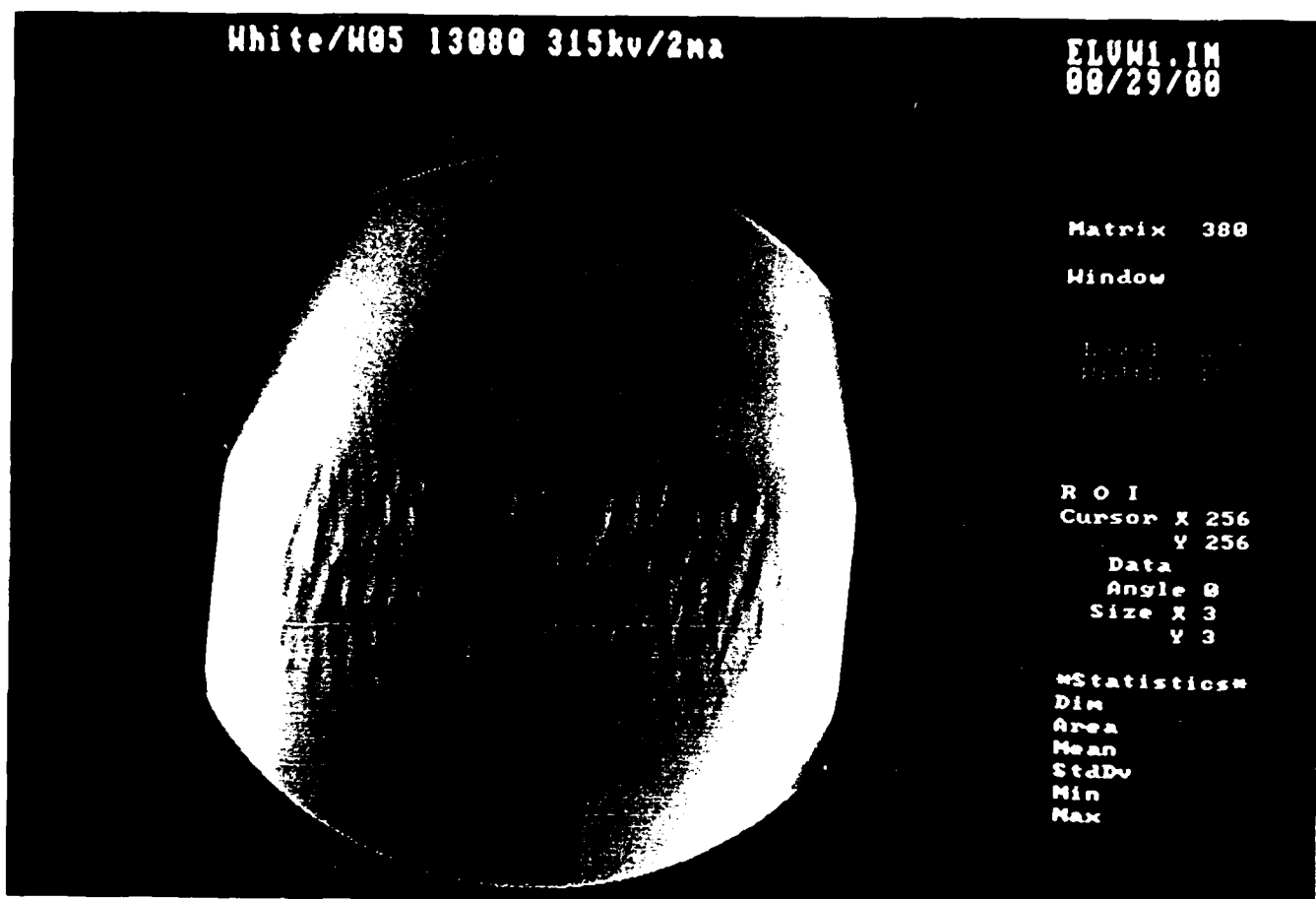

Figure 16. This is a limited view reconstruction over 40°. Many of the low density features are visible, but the higher density S2 layers are too subtle for this method.

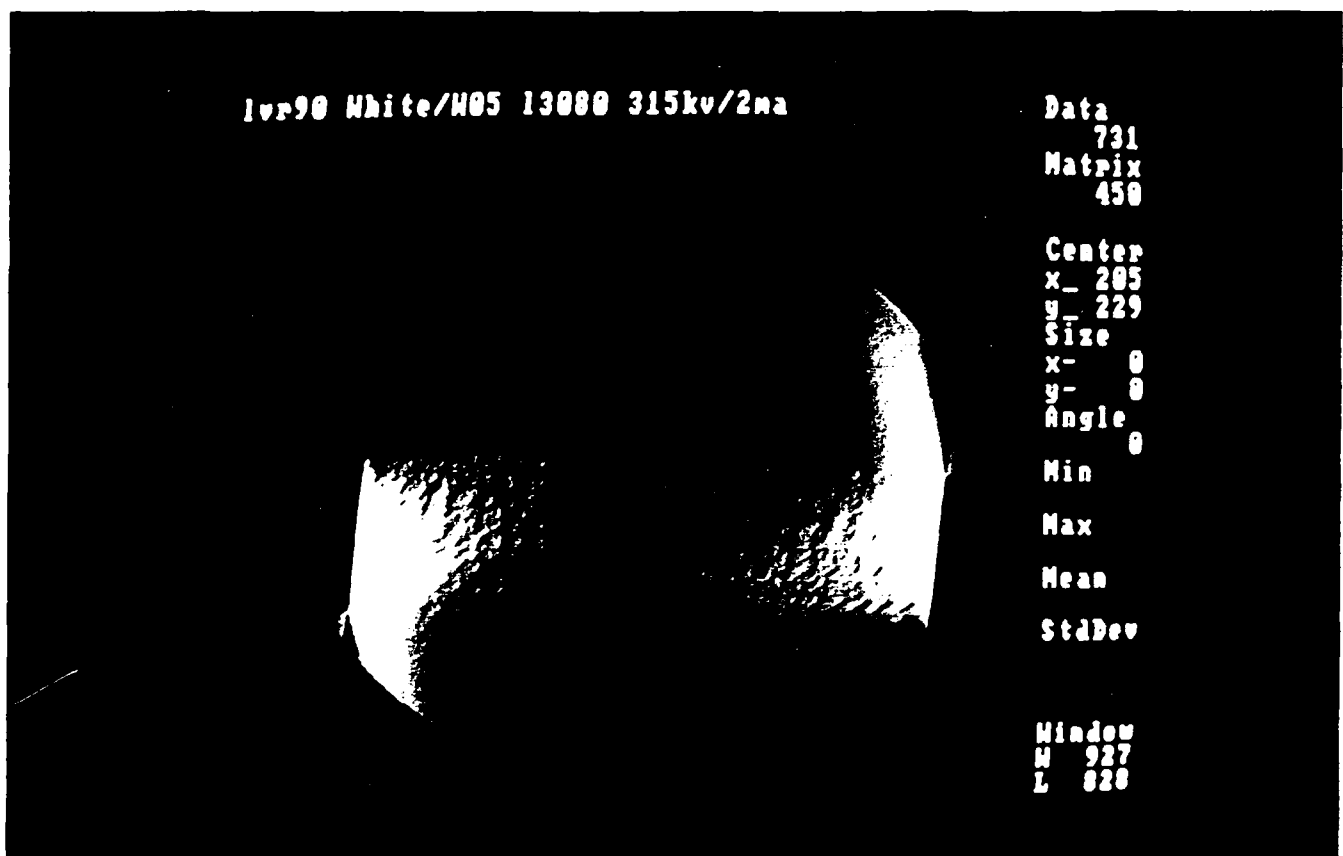

Figure 17. This is a limited view reconstruction over 90°. The low density features are better defined, but the high density material is still not visible.

Number Seven Test Sample

Full View CT Data—was taken at 320 kV, 1.5 mA. The raw data is shown in Figure 18 and the full reconstruction is shown in Figure 19. Note that many of the low density features are visible within the

sinogram data. It may be possible to do much of the analysis from the raw data set. It does depend on what type of feature is important to the application. In the full reconstruction, the low density features are very well defined in terms of size and position within the cross-section. Also, the high density S-glass layers are easily seen.

Limited View CT Data—highlighted the low density features within the cross-section but could not image the high density information.

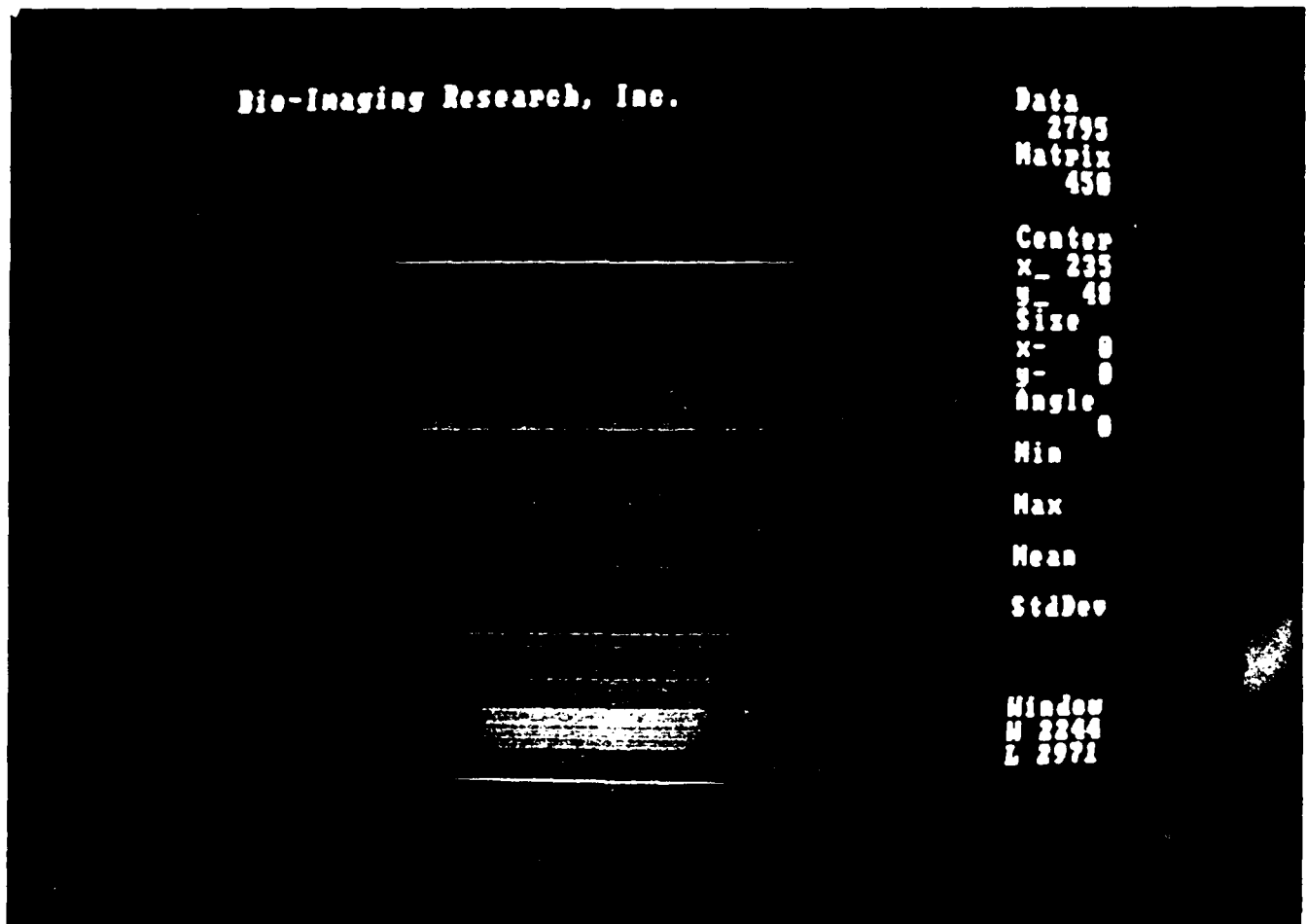

Figure 18. This sinogram of the Number Seven Test Sample shows many of the low density features as dark vertical streaks.

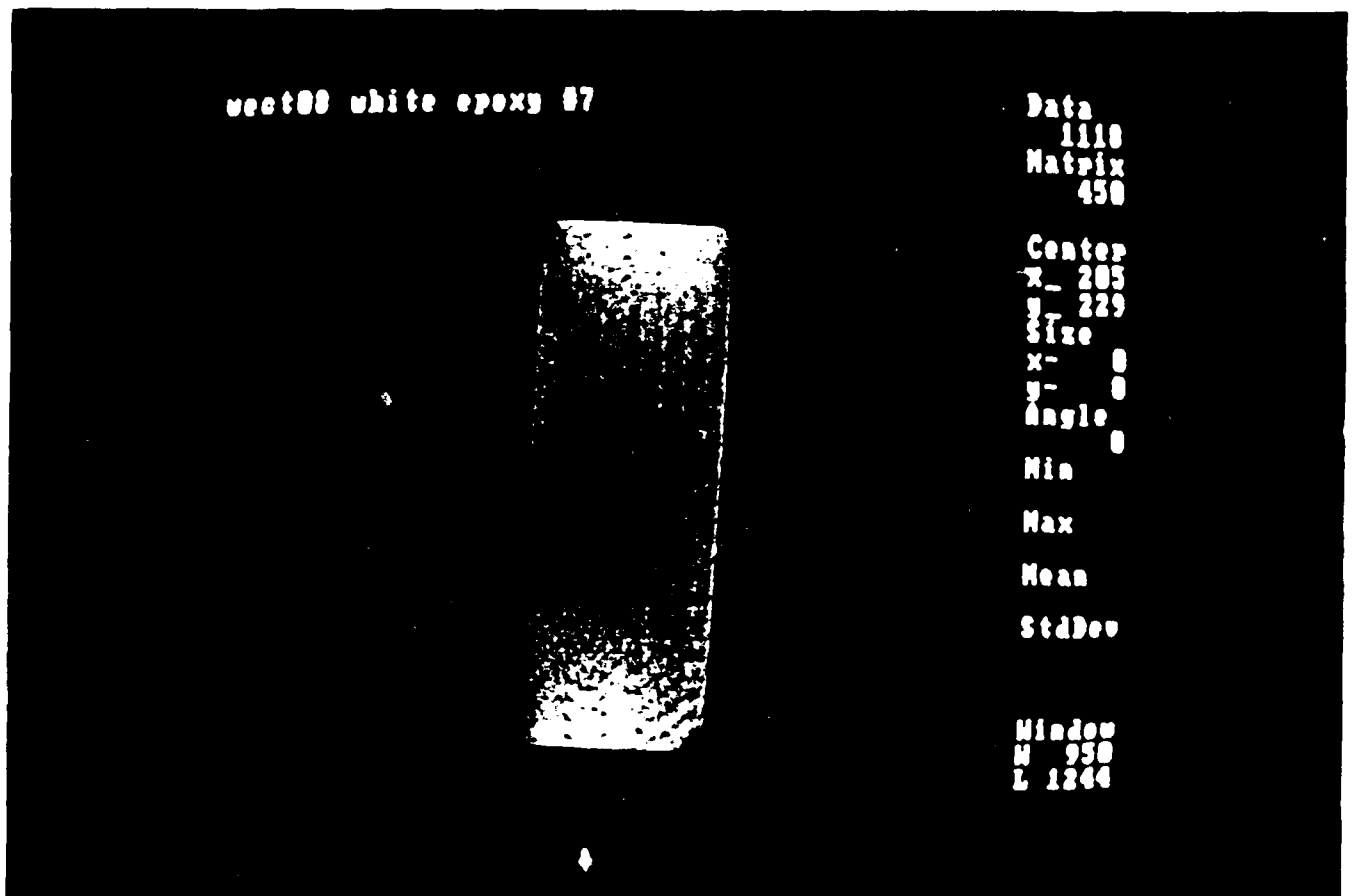

Figure 19. In this full view CT reconstruction, both low density and high density S-glass layers can be seen.

Summary of Armor Evaluation

The digital radiography data that was taken for the first two samples indicated that the DR mode was incomplete in its cross-sectional information. The low density matrix rich areas, which are quite easily

defined in the full view CT images, are marked by a surface pattern in the DR image making it difficult to analyze. DR information is taken from x-ray photons that are normal to the ply structure of the material. This means that features that are delaminate in nature are very difficult to see. We did not continue to pursue the DR experiments beyond this point because they did not offer a data set comprehensive enough for composite material analysis.

A simple dual energy weighted subtraction technique was used to analyze the dual energy possibilities for this application. The results were disappointing. The feature structure remained the same and no new information was available. We concluded that this form of dual energy analysis was not a productive approach for the Phase I study.

Full view CT images gave excellent detailed presentations of the density structure of the material. Low density matrix rich areas were quite easy to pick out and quantify. The high density S2 glass layers could be seen, but the data was subtle and did not have the necessary signal-to-background ratios for reliable detection by automated analysis.

Limited view CT reconstructions offer a potential technique for cross-sectional analysis of the armor. The actual material is manufactured in large hulls and sheets. This would be impossible to scan with standard CT data collection techniques. The limited view approach to data collection for this material appears to be the only possibility for characterization using CT. Ninety degree data collection is possible using a wide angle linear detector and a panoramic x-ray tube. The 90° characterization offers fairly detailed information and could be pursued for standard evaluation of this material.

5.2 Helmets

Helmets are manufactured from Kevlar plies with a polyvinylbutyral matrix material. The material is molded under pressure from tooling structured to maintain a constant thickness. The molding cycle is approximately nine minutes long with the temperature held at about 300°F. The prepreg matrix in the ply cloth flows during the molding operation so that no additional matrix has to be added.

Important criteria for helmet acceptance is the knowledge that all 19 plies are in place over the complete helmet surface and that the appearance of the helmet is acceptable. Delaminations in the ply structure can also be a problem and inspection should be able to determine this type of defect. The present method of testing is ballistic by firing a 22 caliber projectile at the helmet surface. This ballistic method is applied to random samples to determine if a lot has been correctly manufactured.

Three helmet samples were analyzed:

- Dome Sample Number Four with plies missing and with delaminations
- Dome Sample Number Five with plies missing and with delaminations
- Small Helmet apparently manufactured correctly

Helmet samples were mounted on the Radapt 2 gantry as shown in Figures 20 and 21. The samples were examined using 250 kV and the 0.8 mm x-ray tube focal spot. This focal spot limits the tube current to 1.5 mA. A detailed description of each analysis follows.

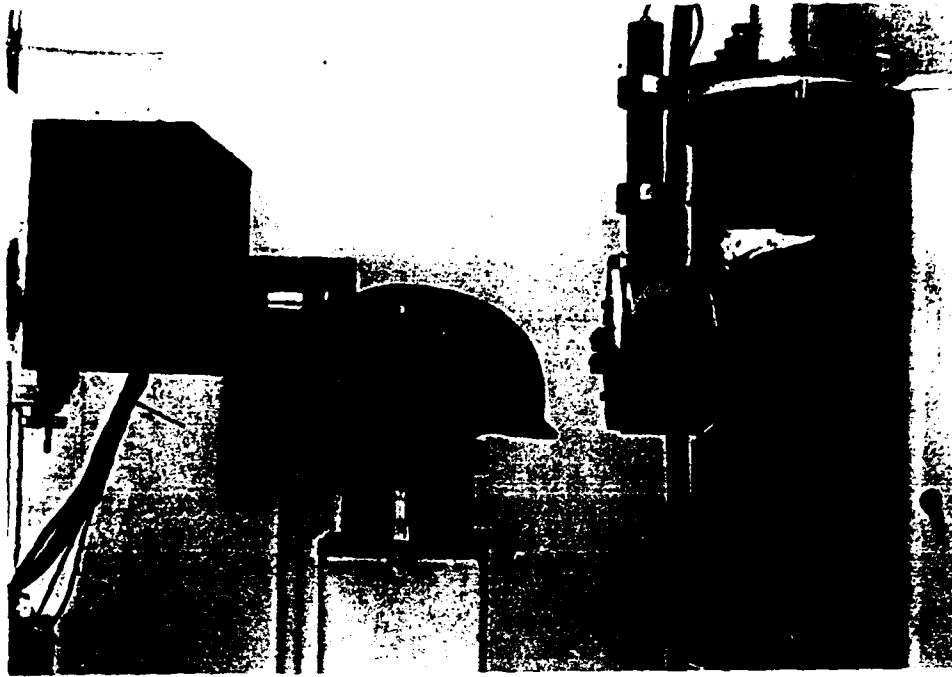

Figure 20. The helmet sample is mounted on Radapt 2 for analysis.

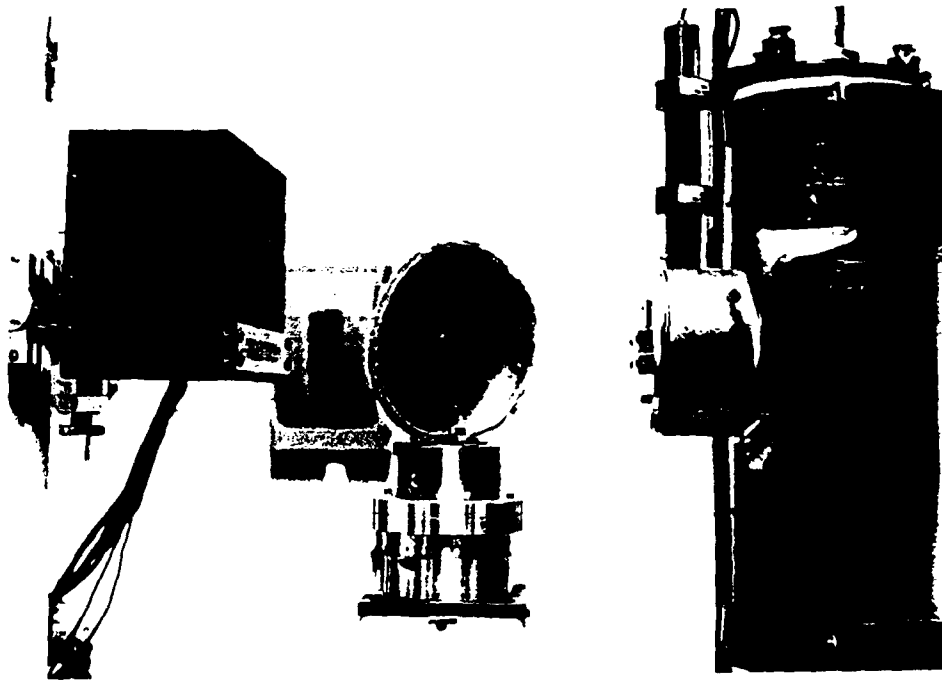

Figure 21. The helmet sample is mounted in another configuration on Radapt 2.

Small Helmet

The Small Helmet is shown in Figure 22.

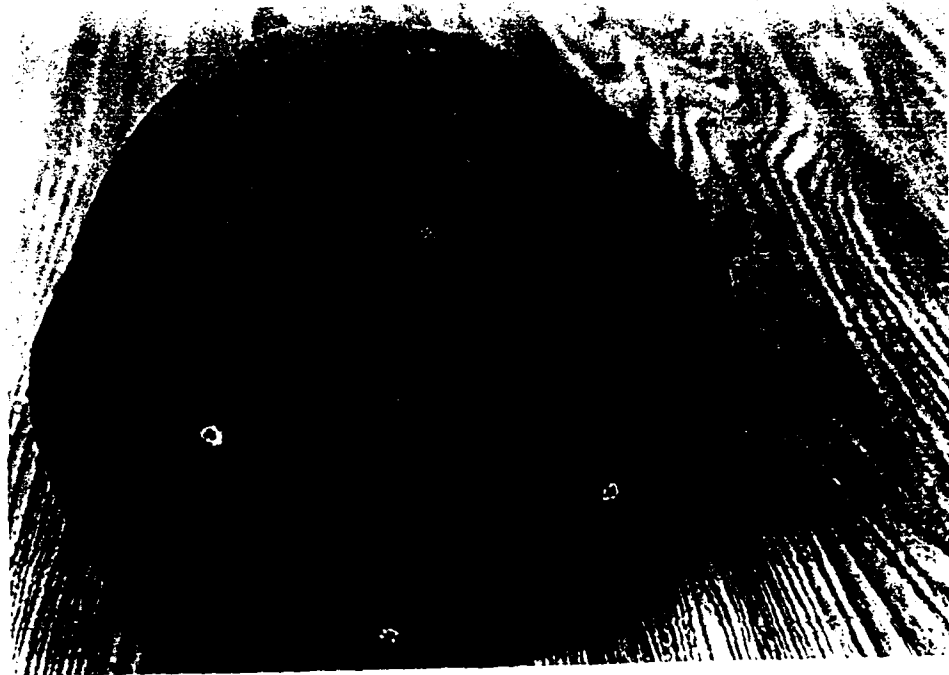

Figure 22. The Small Helmet sample was evaluated on Radapt 2.

DR Data—shows internal features in Figure 23. Attenuation through the helmet can be accurately measured using this technique, however, it would be difficult if not impossible to correlate the attenuation numbers with a lack of ply structure. The helmets are very accurately molded to the same thickness using the old tooling therefore, the lack of a ply would be filled in with matrix material and attenuation measurements would not be accurate enough to detect a missing ply.

Full View CT Data—is shown in Figure 24.. Scan time for this particular slice was 10 minutes and reconstruction time was 7 minutes. The data collection rate could be increased by a factor of two if a third generation CT data collect technique was used rather than the second generation provided by Radapt 2. Reconstruction time can be also reduced significantly, perhaps by a factor of ten with the use of high speed computer systems.

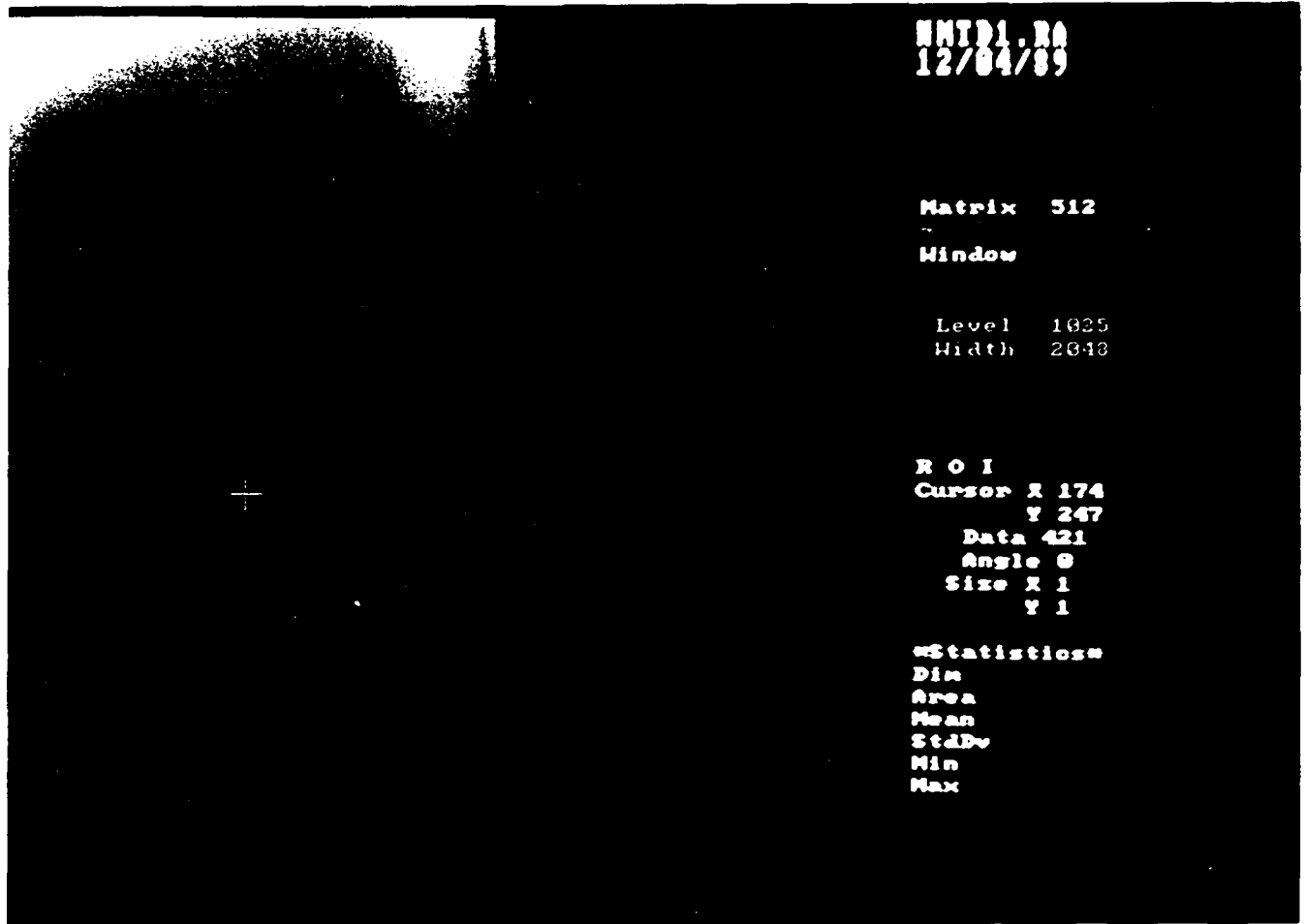

Figure 23. This DR image of the Small Helmet shows internal features.

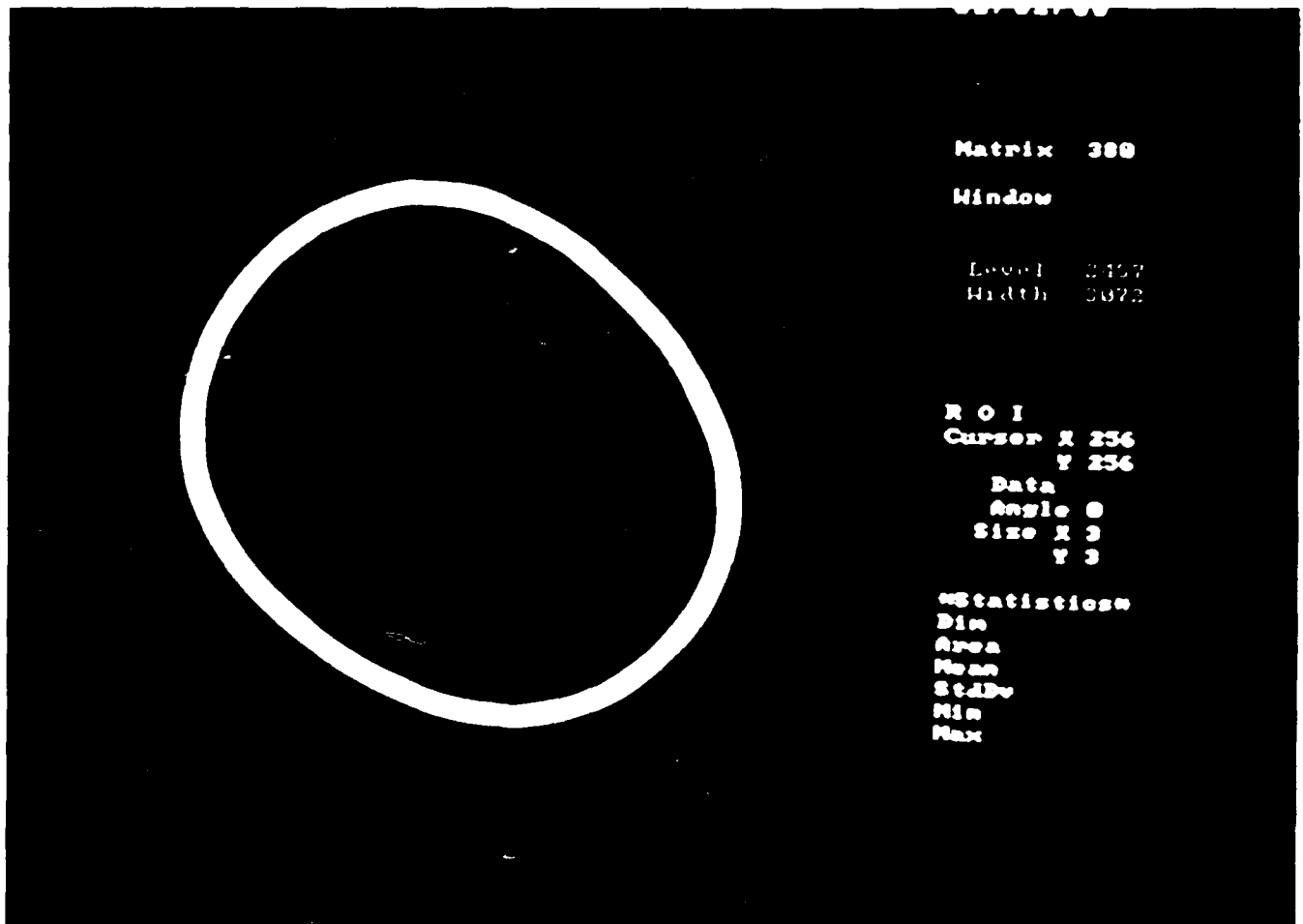

Figure 24. This CT image of the Small Helmet shows the helmet cross section.

Dome Sample Number Four

The Dome Sample Number Four is shown in Figure 25.

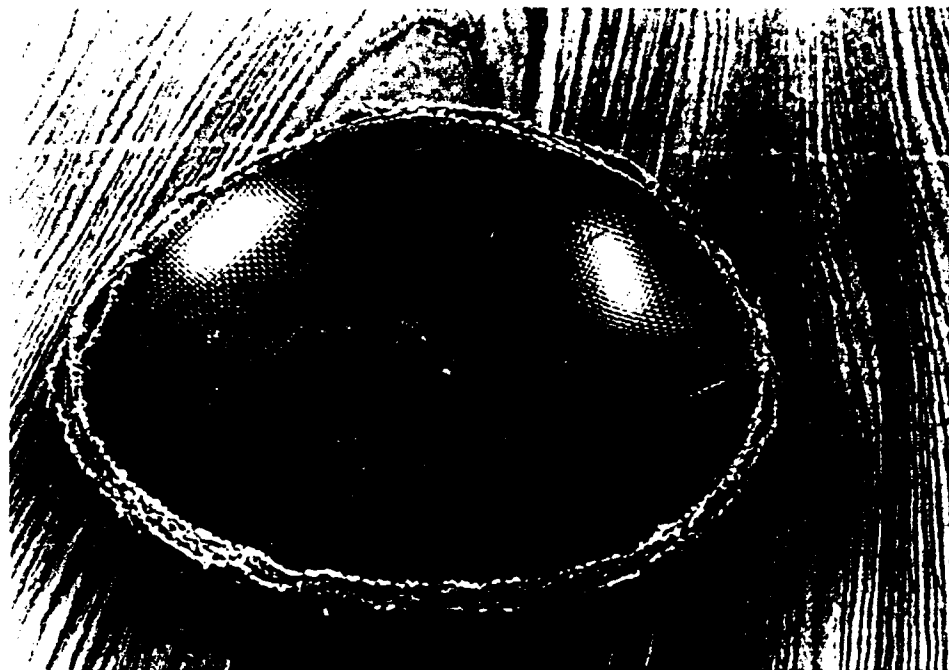

Figure 25. The Dome Sample Number Four is shown.

Full View CT Data—is shown in Figure 26.

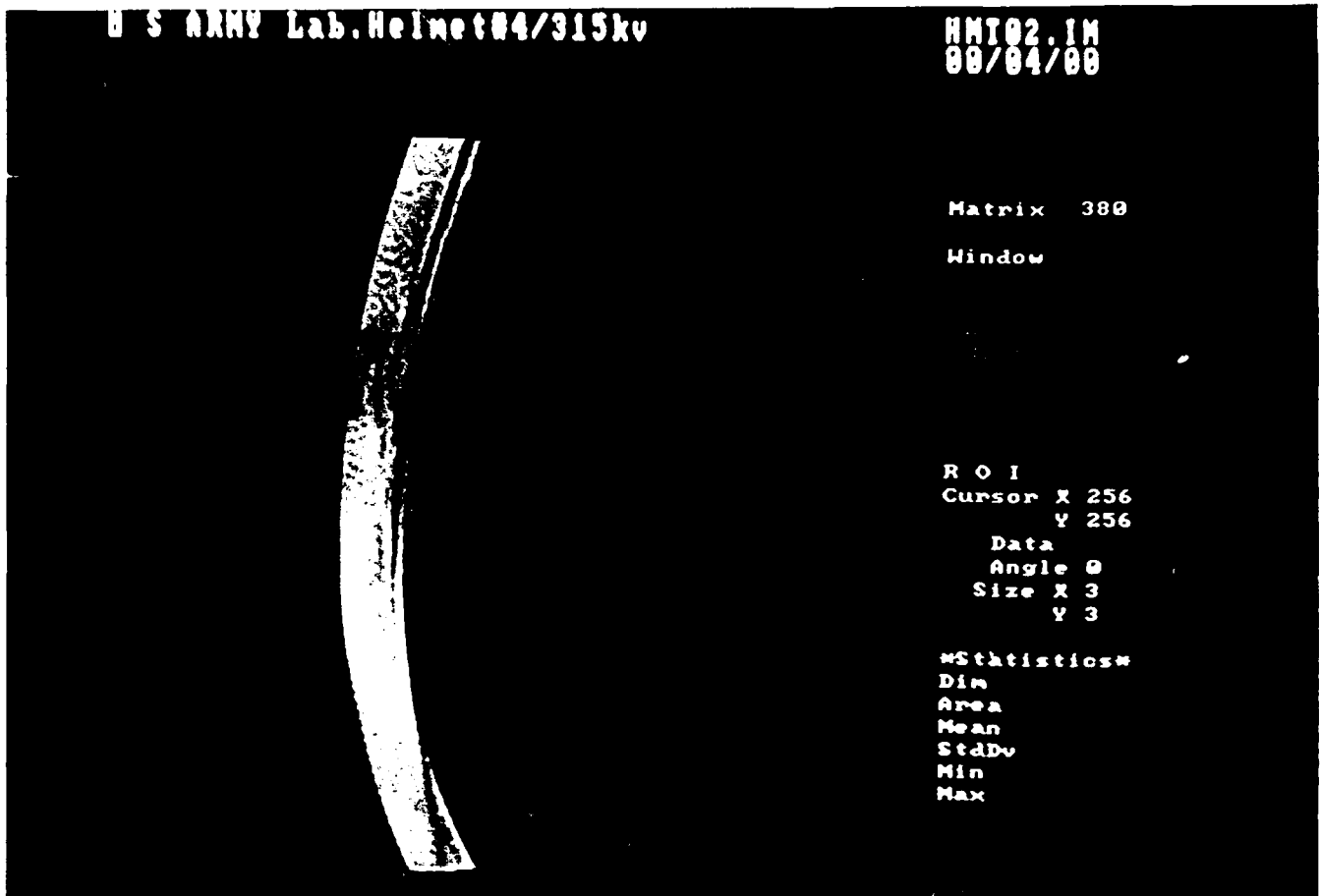

Figure 26. Full view CT reconstruction of Dome Sample Number Four is shown. A delamination is clearly visible on the right.

Dome Sample Number Five

Full View CT Data—is shown in Figures 27, 28 and 29. Zoom reconstructions shown in Figure 28 and 29 have much greater detail than the full field image in Figure 27.

Limited View CT Data—is shown in Figures 30 and 31; both were 40° data sets. Figure 30 used a data set that was normal to the ply structure; Figure 31 used a 40° data set that was parallel to the ply structure.

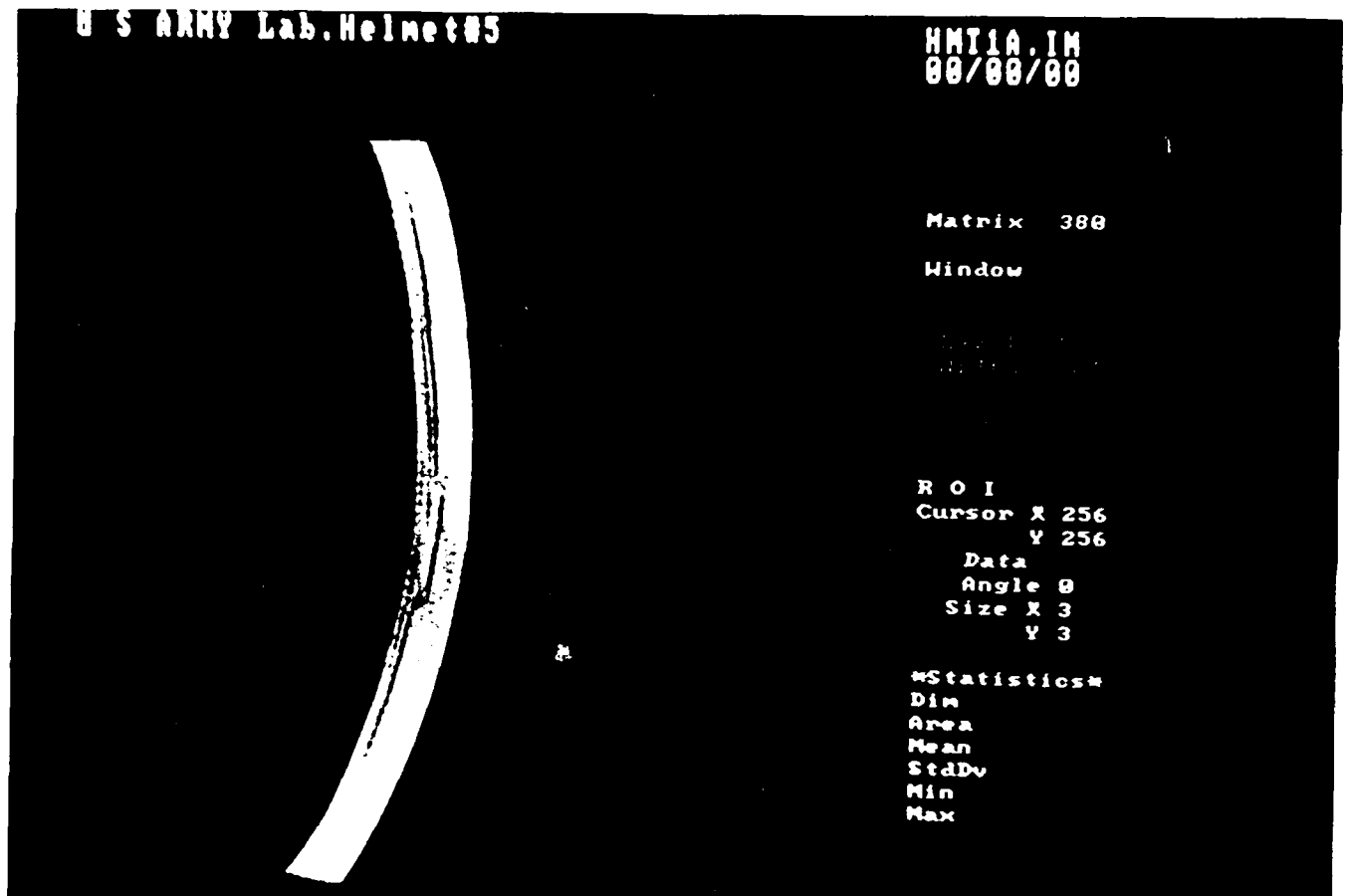

Figure 27. This full view CT image of Dome Sample Number Five shows delaminations..

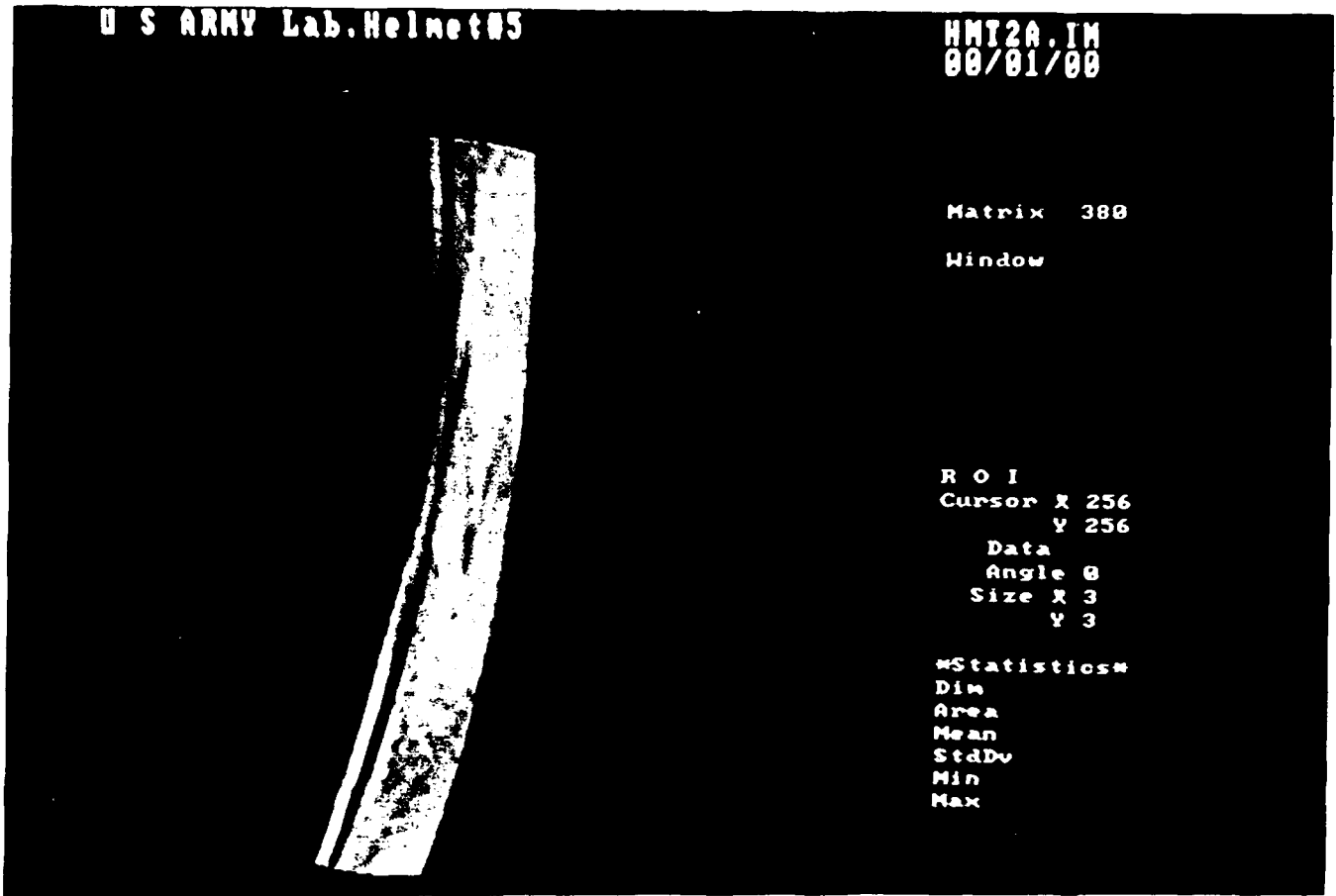

Figure 28. This is a full view zoom reconstruction of Dome Sample Number Five with good resolution.

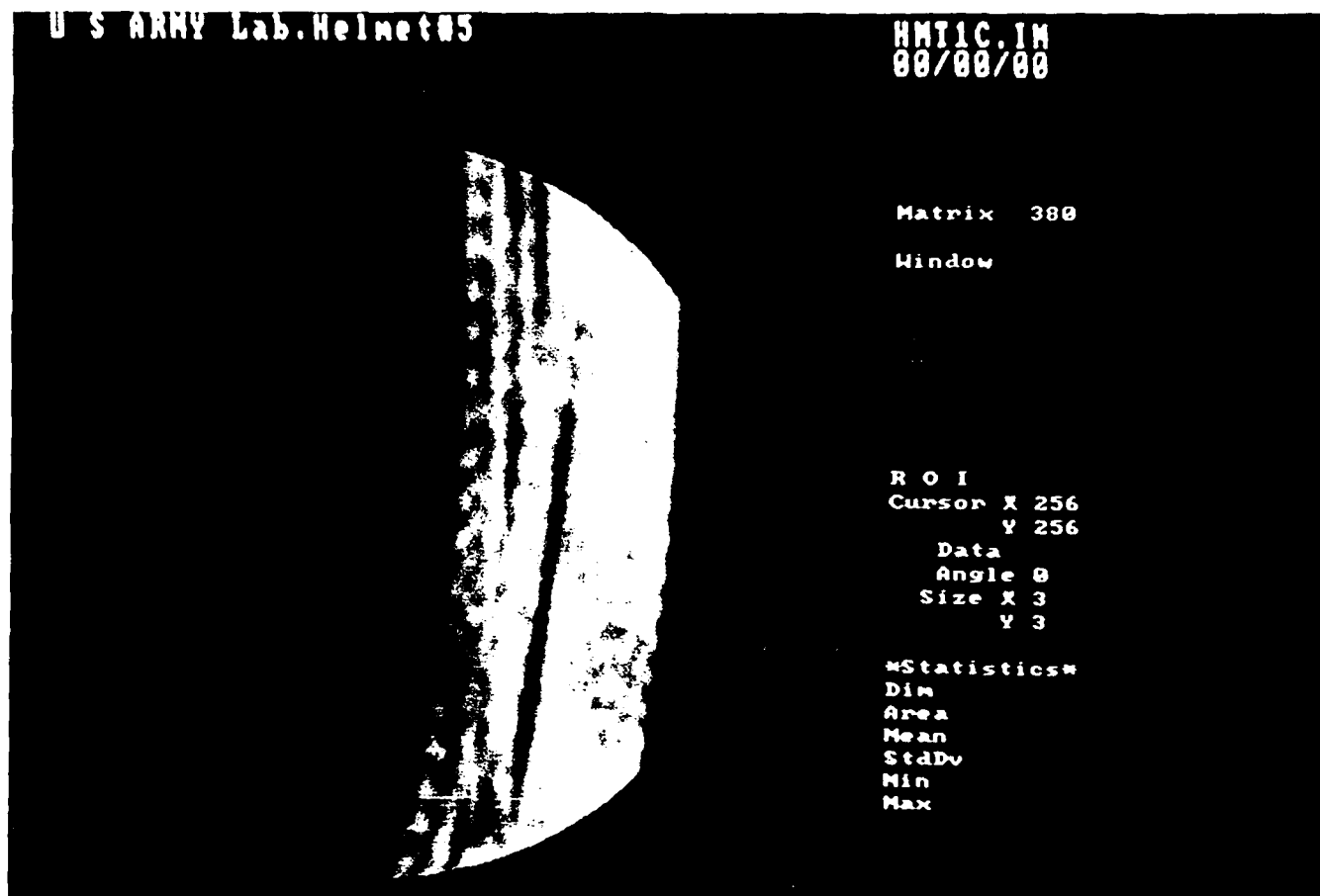

Figure 29. This is a still larger zoom reconstruction of Dome Sample Number Five; detail is maintained.

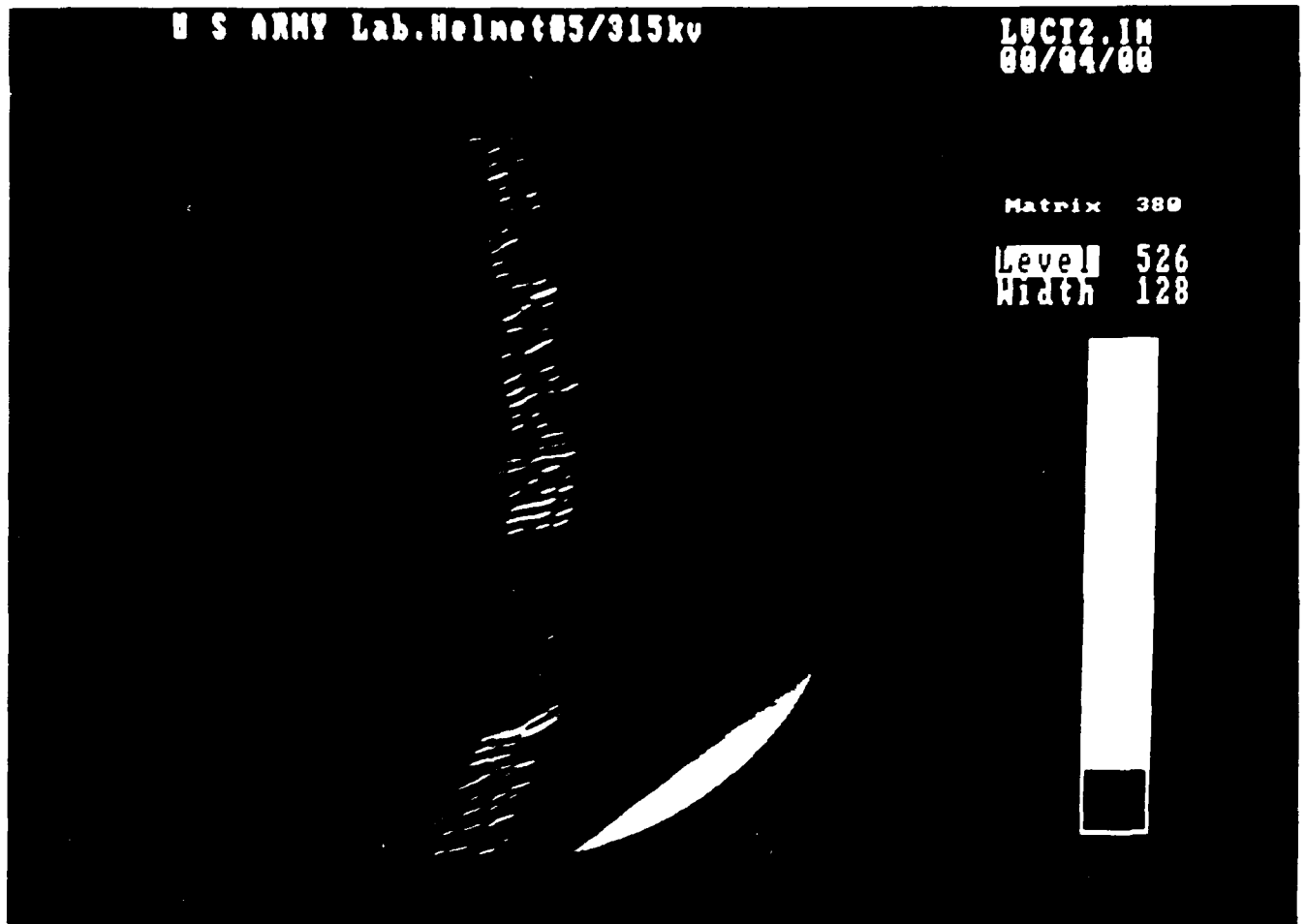

Figure 30. This is a 40° limited view reconstruction of of Dome Sample Number Five. Views are normal to the helmet wall. The image provides little information.

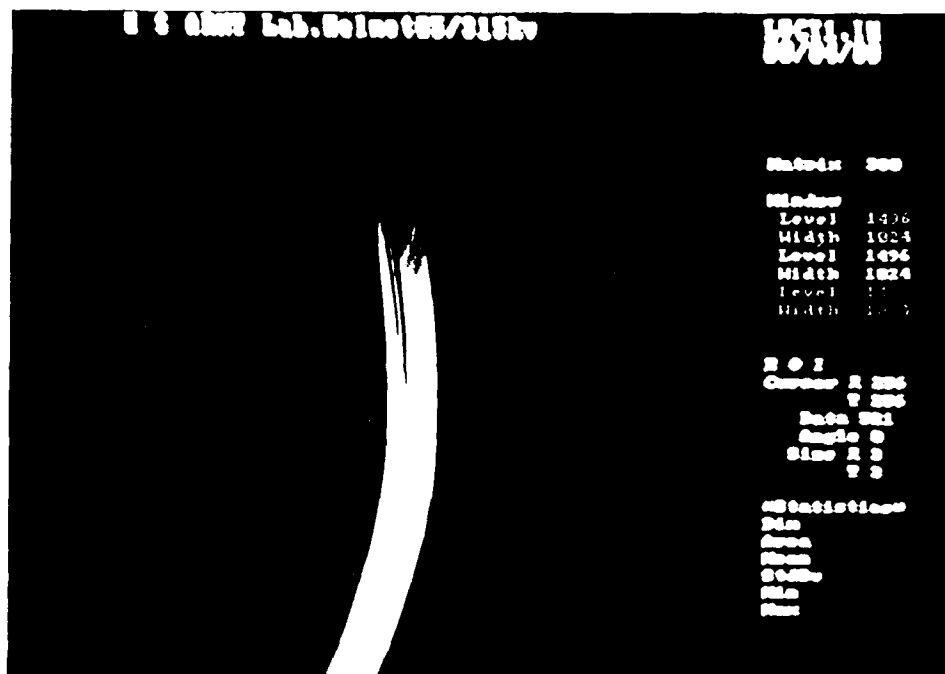

Figure 31. This is a 40° limited view reconstruction of of Dome Sample Number Five. Views are parallel to the helmet wall. Virtually complete cross-sectional information is provided.

Summary of Helmet Evaluation

Radapt 2 was unable to separate the elements of the helmet structure well enough to reliably count the plies. Reconstructions of the dome segments (Figures 27 and 31) show excellent detail of the delaminations that have occurred, but they do not resolve the individual plies. This is in spite of the fact that Radapt 2 has a spatial resolution of 4 line pairs/millimeter—among the best in the industry for a standard industrial CT system. This spatial resolution is based on imaging 1/8 mm high-density elements separated by 1/8 mm of (low-density) air.

Other factors need to be considered. The display system would not have the resolution to show the plies because the reconstruction field is so large (see Figure 24). The plies are difficult to separate

because the ply-to-ply spacing is very small and is filled with a matrix material that has a density similar to the ply material.

Approximately 250 slices would be necessary to completely characterize a helmet. Even at the most optimistic time estimates, this would take approximately 40 minutes. Justification of this inspection time would be difficult in a production environment.

The computed tomography and limited view tomography cross-sections do have the ability to characterize density variations and delaminations within the helmet structure. This can be important for determining the functional capability of the helmets.

5.3 Pultrusion Samples

The pultrusion samples were glass/epoxy bars pultruded using E-glass fibers and epoxy resin matrix. The pultrusion process is continuous using blocks to pull the material through forming dies. Pultrusion is less forgiving than other molding processes, and requires tight control of variables to achieve a quality product. The most important characteristic necessary to maintain quality is the control of density along the length of the bar. Variations in processing can cause a wide variation in the quality of the material.

The following samples were tested:

- Processing Code Number 30: manufactured at a line speed of 3 inches/minute with a fiber content of 61.38% glass
- Processing Code Number 32: manufactured at 3 inches/minute with a fiber content of 67.39% glass
- Processing Code Number 60: manufactured at 6 inches/minute and a fiber content of 61.38% glass.

Samples were mounted on the Radapt 2 as shown in Figure 32. DR images were taken of the entire bar. CT images were taken at various positions (cross sections) in the sample. The images were taken at 315 kV, 1.5 mA with the 0.8 mm focal spot. A detailed description of each test piece follows.

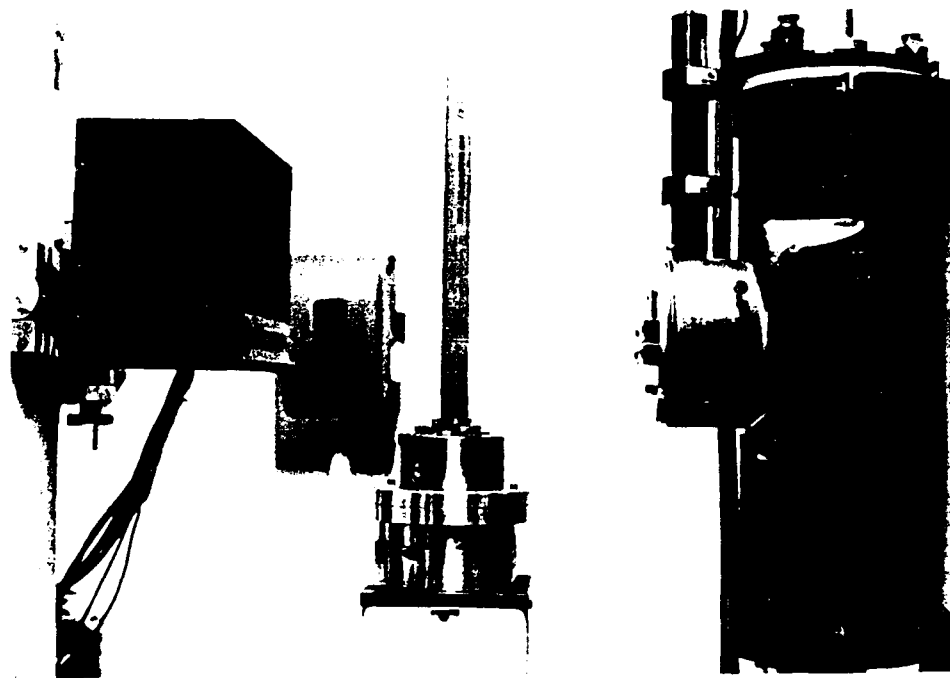

Figure 32. The pultrusion sample is mounted on Radapt 2 for analysis.

Processing Code Number 30

The Processing Code Number 30 sample is shown in Figure 33.

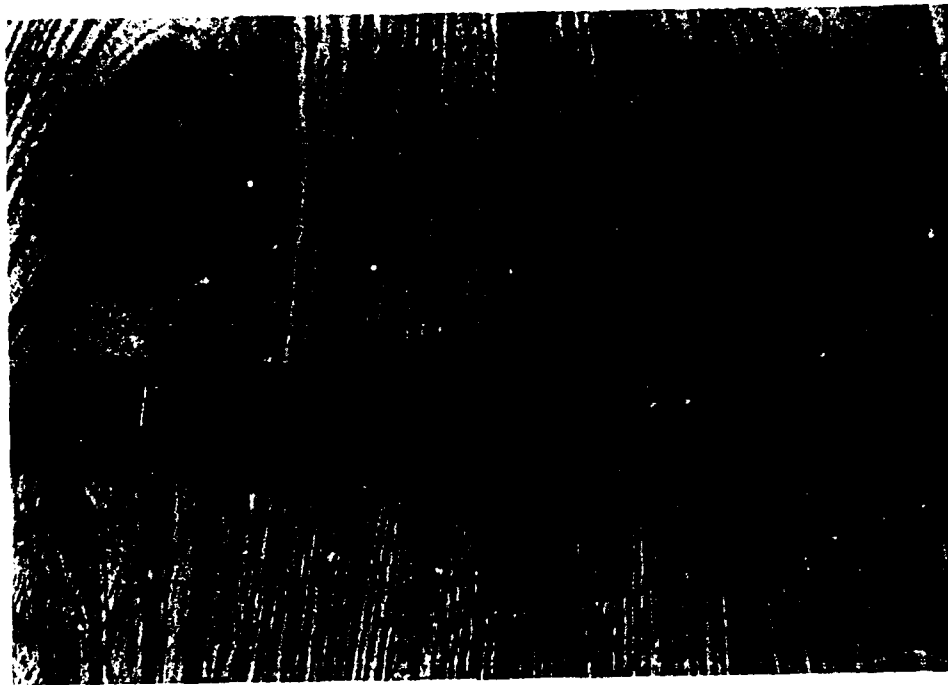

Figure 33. Processing Code Number 30 pultrusion sample is shown.

Full View CT Data—is shown in Figure 34. The image gives a detailed picture of the density variations in the cross-section. This incremental density map shows the arrangement of the fibers and the lower density matrix-rich areas that have developed in the structure.

Limited View CT Data—a 40° reconstruction as shown in Figure 35. The low density features are distinguishable from the background, but their detailed structure is not visible. The higher density fibers are not visible in the mapping.

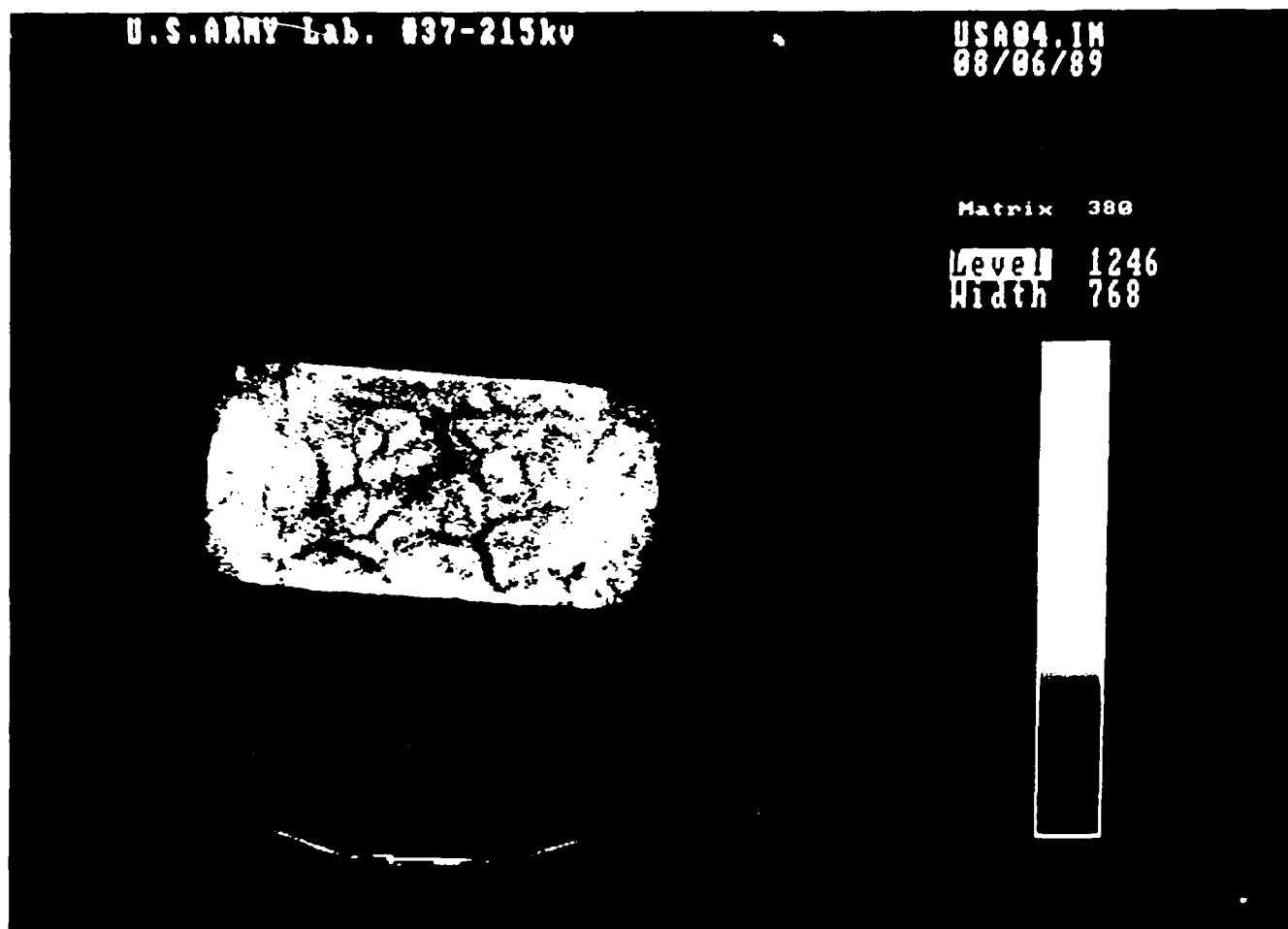

Figure 34. This pultrusion sample manufactured with Process 30: 3 inches/min, 61.38% glass. A complete reconstruction provides well defined low density features.

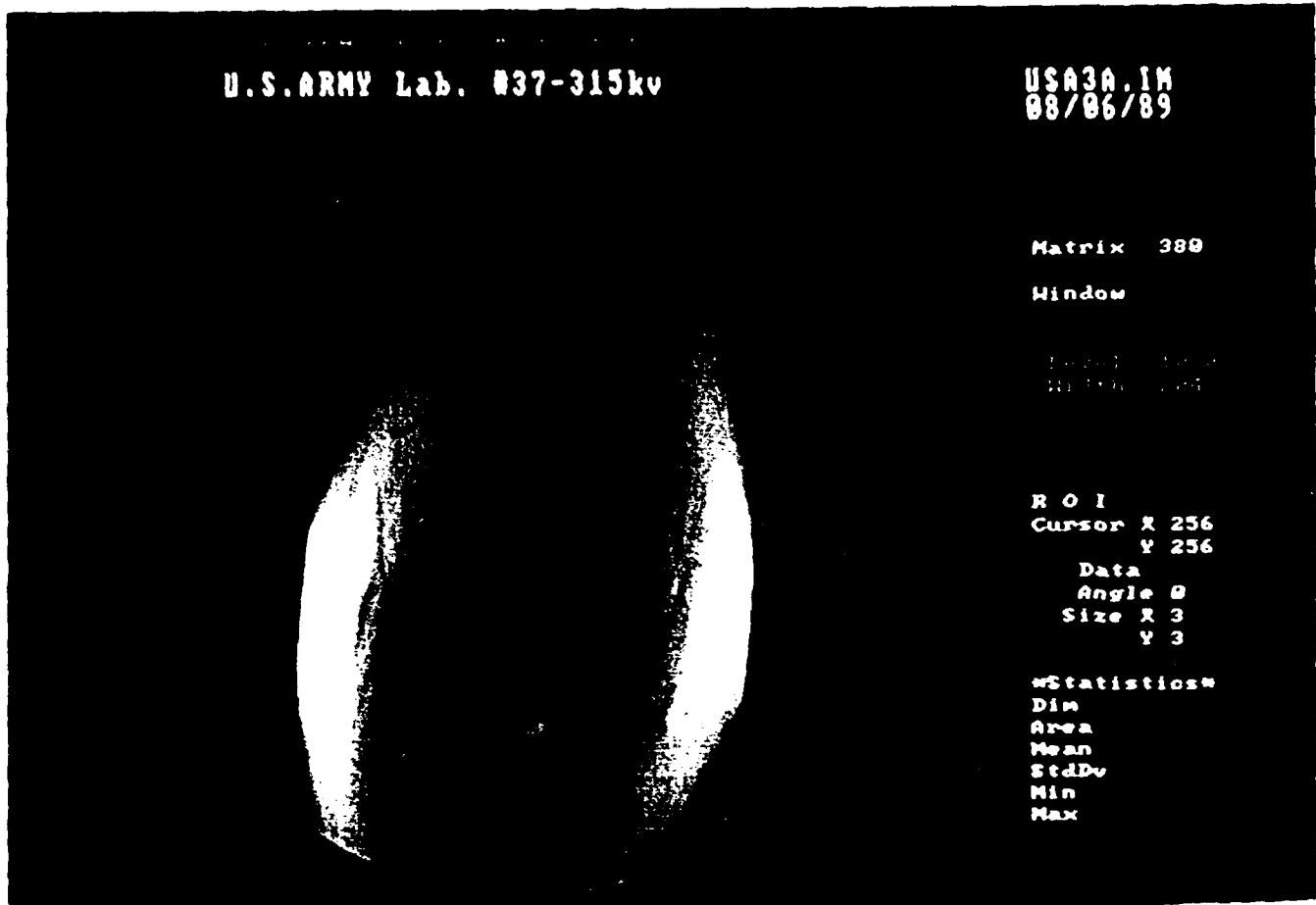

Figure 35. This Processing Code 30 pultrusion image is a 40° limited view reconstruction. Details of the defects are not presented, but is quite obvious that defects exist.

Processing Code Number 32

The Processing Code Number 32 sample is shown in Figure 36.

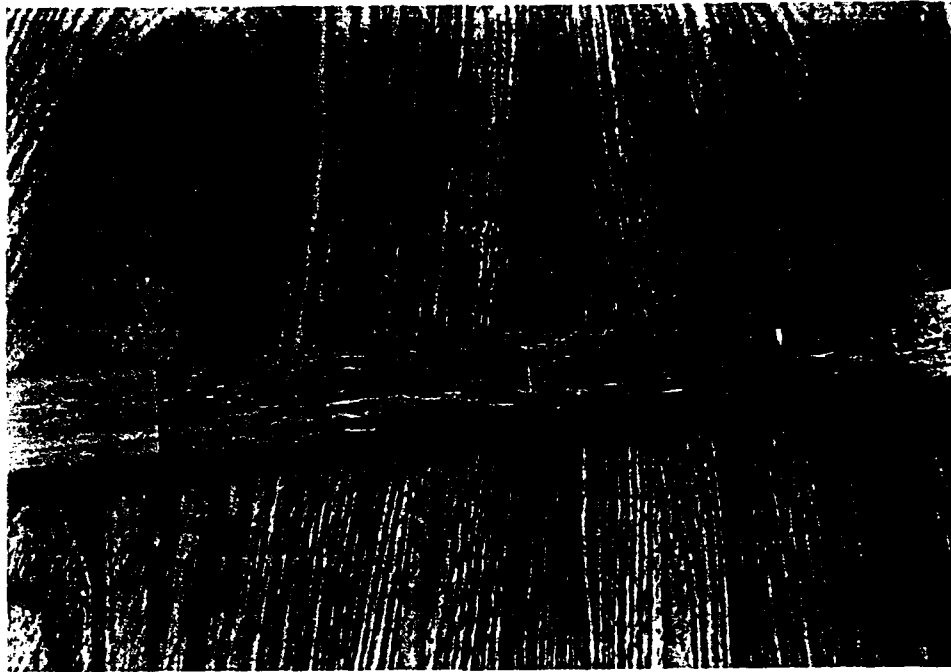

Figure 36. Processing Code Number 32 pultrusion sample is shown.

Full View CT Data—is shown in Figure 37. A detailed density map is available from this data set. This cross-section has a consistent density structure as compared to the other samples.

Limited View CT Data—from a 40° reconstruction is shown in Figure 38. Even though this bar has a very consistent density cross-section, as seen in Figure 37, we can still see variation in the 40° reconstructed image. This is a strong indication that a limited view reconstruction can give us information over the full range of density variation in the samples.

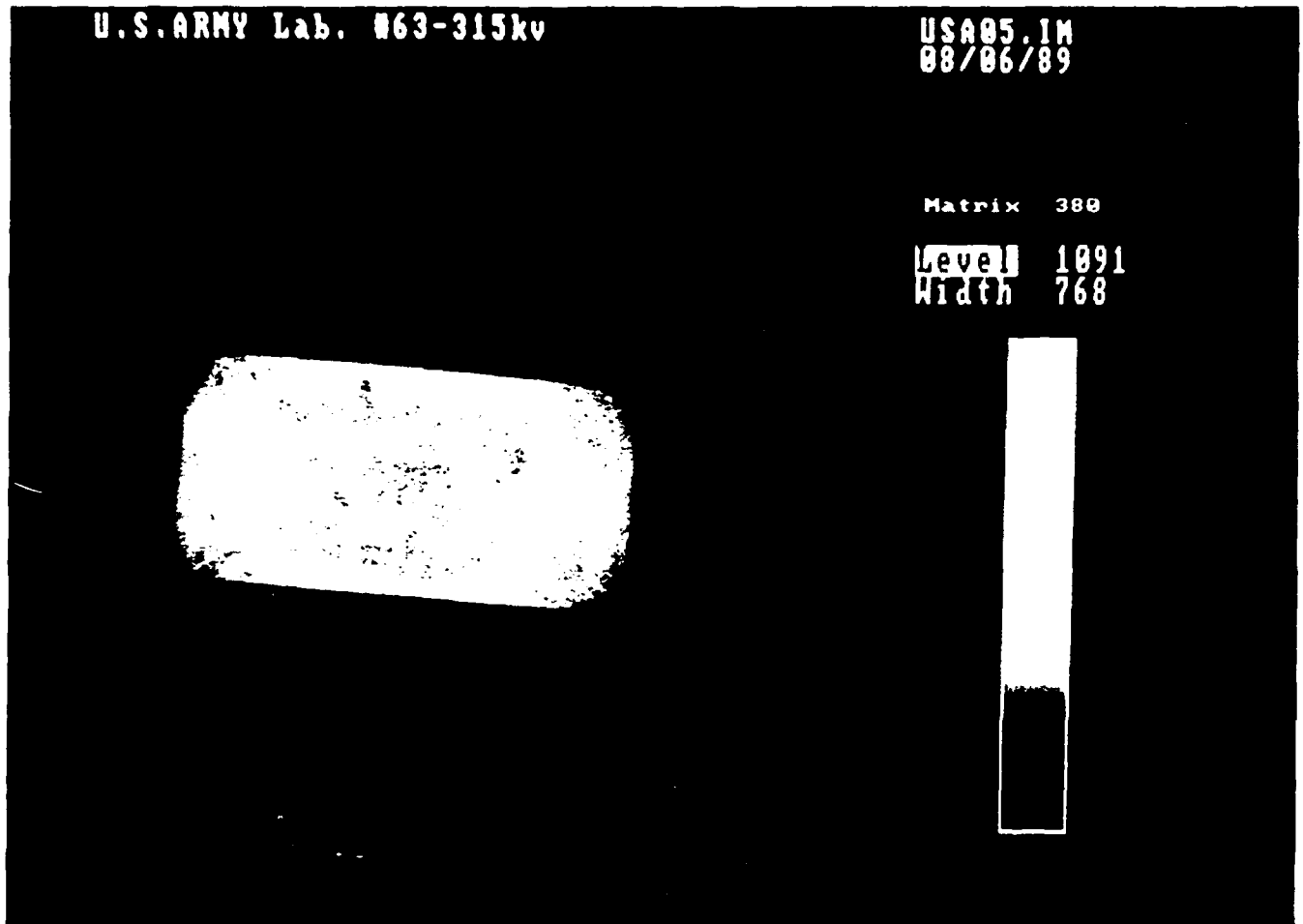

Figure 37. This Processing Code 32 image is a full view CT reconstruction and has very few low density features.

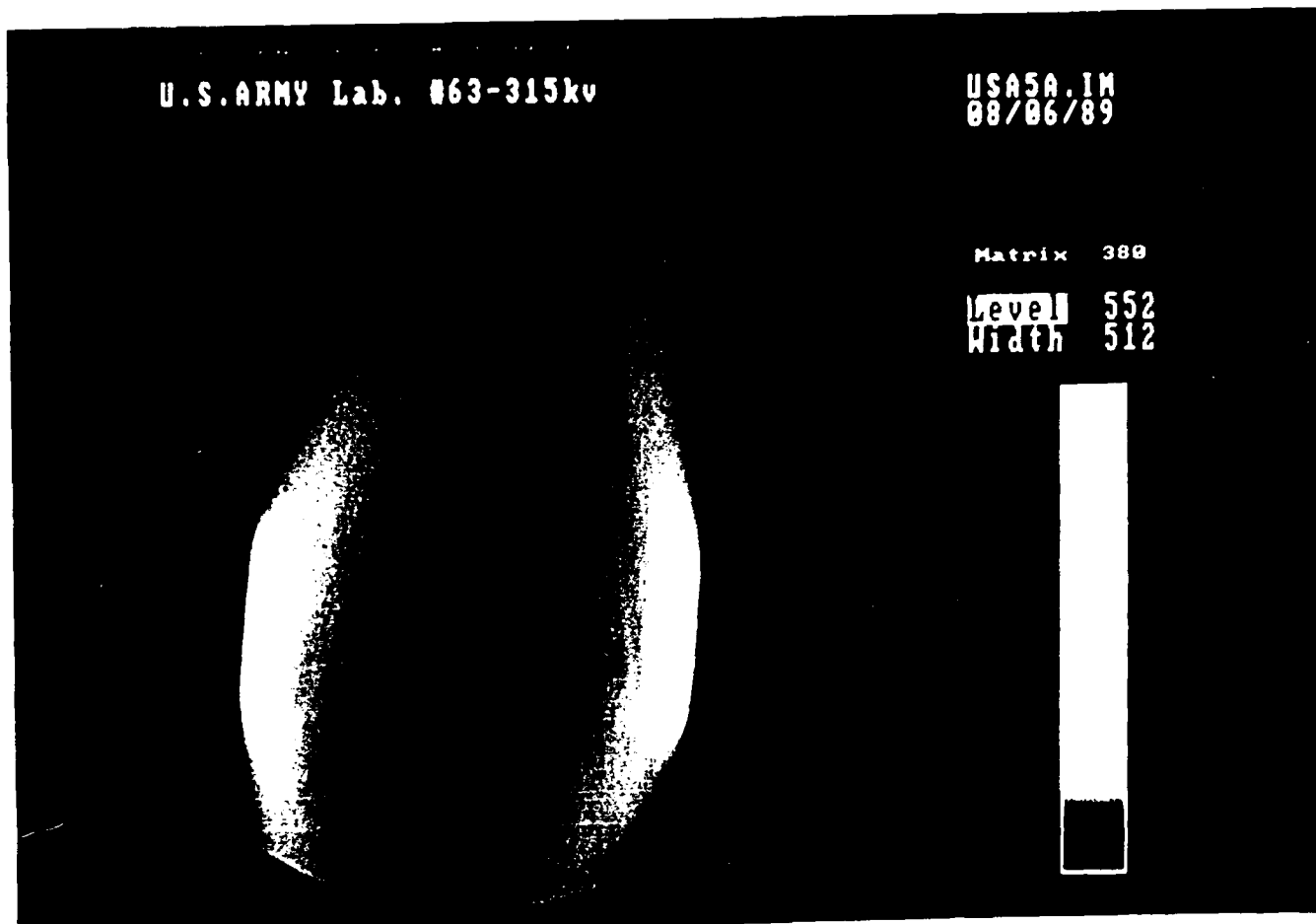

Figure 38. This Processing Code 32 pultrusion image is a 40° limited view reconstruction. Few features are evident.

Processing Code Number 60

The Processing Code Number 60 sample is shown in Figure 39.

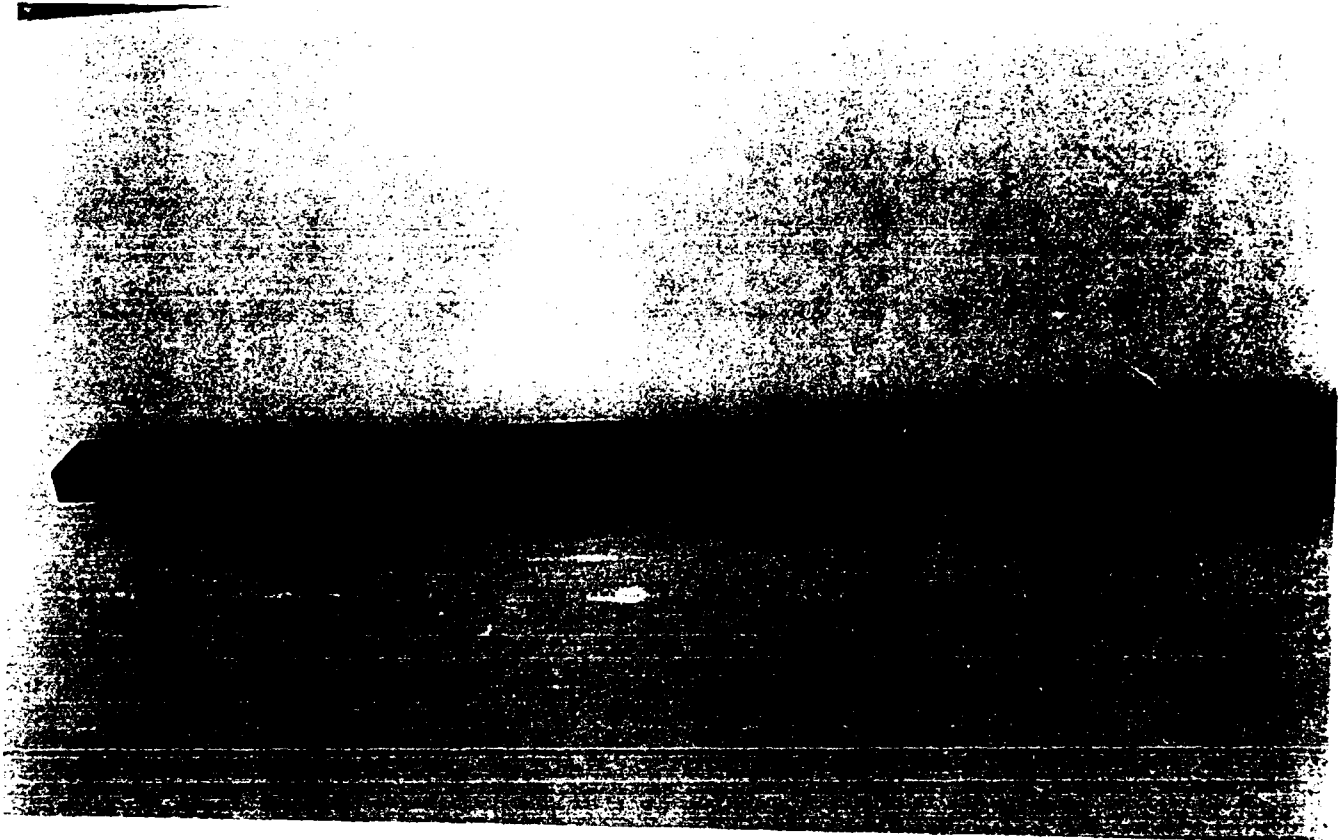

Figure 39. The Processing Code 60 pultrusion sample is shown.

Full View CT Data—is shown unreconstructed as a sinogram in Figure 40. The raw data set from the computed tomography data collect indicates low density features as vertical dark streaks in the image. A complete 180° reconstruction of that raw data set is shown in Figure 41. Again, we have a very detailed density map of the cross-section showing the specific extent and position of low-density matrix-rich areas.

Limited View DT Data—a 40° reconstruction using data that is normal to the small surface of the sample is shown in Figure 42. The density variation can be seen, but at a reduced intensity as compared with limited view reconstruction taken normal to the large surface. Compare Figure 42 with Figure 35. The 40° mapping indicates variation in density but gives only relative position and relative magnitude of variation.

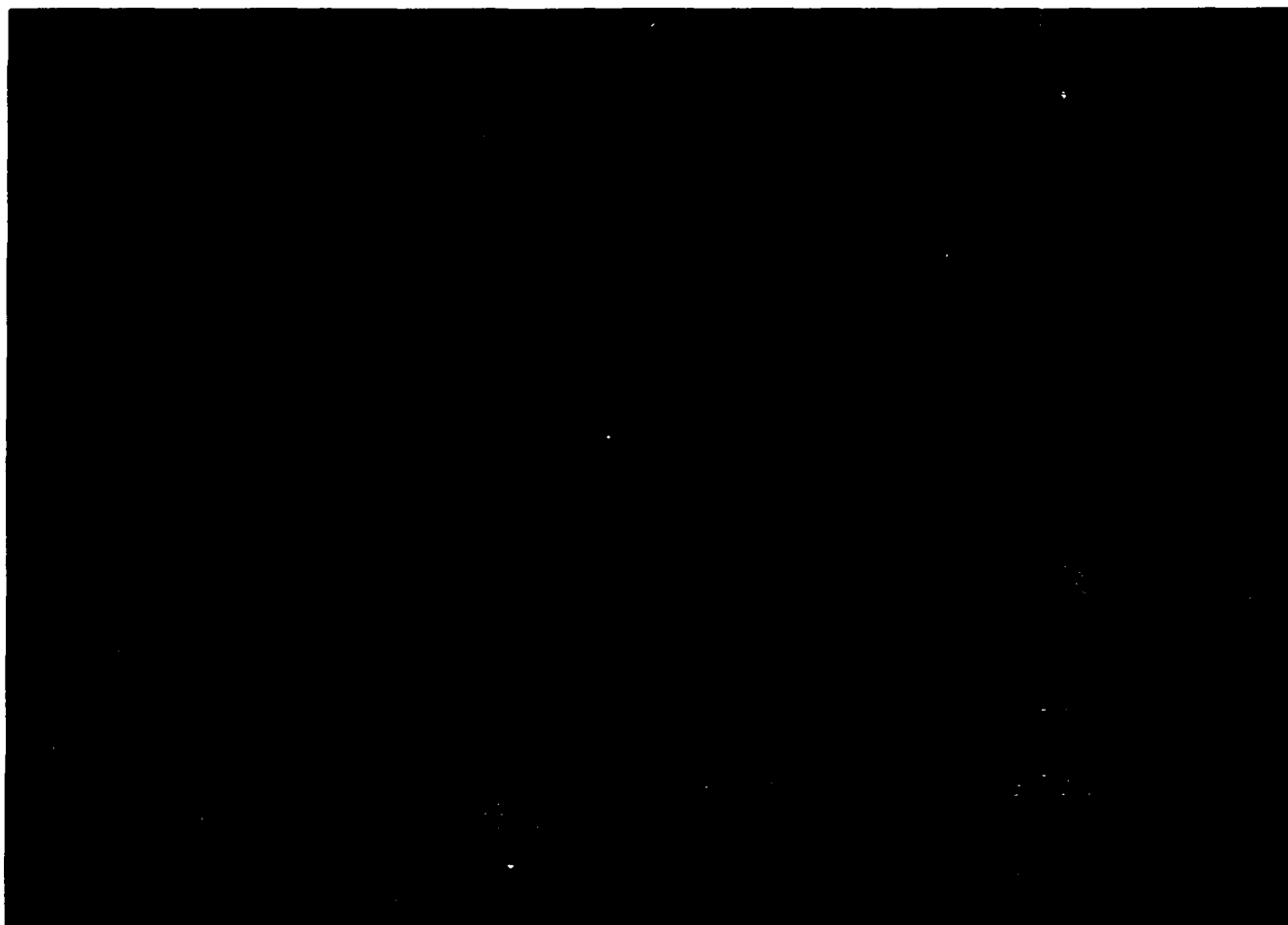

Figure 40. The sinogram shows unreconstructed full view data from the Processing Code 60 pultrusion sample .

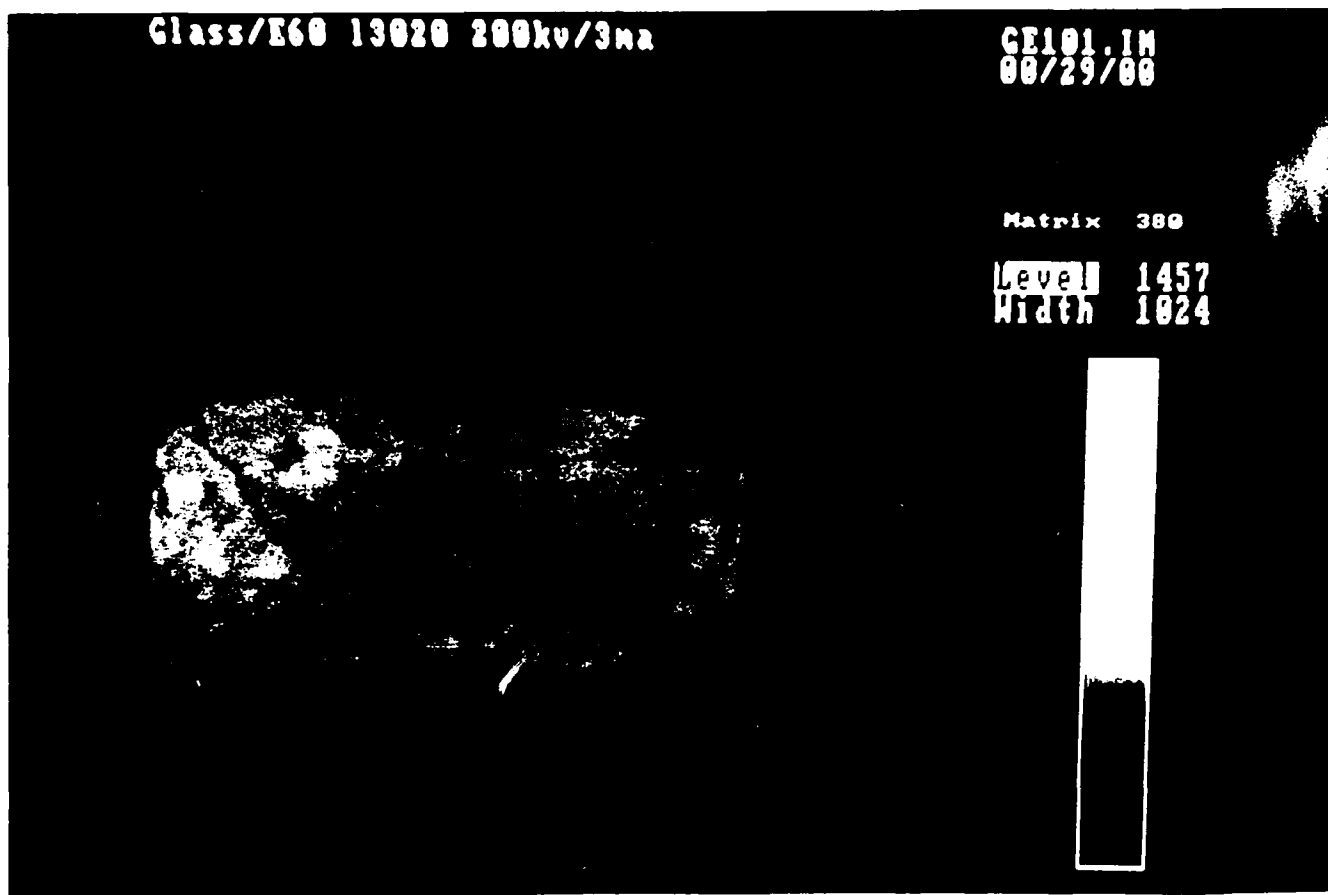

Figure 41. The Processing Code 60 full view CT image shows many low density features.

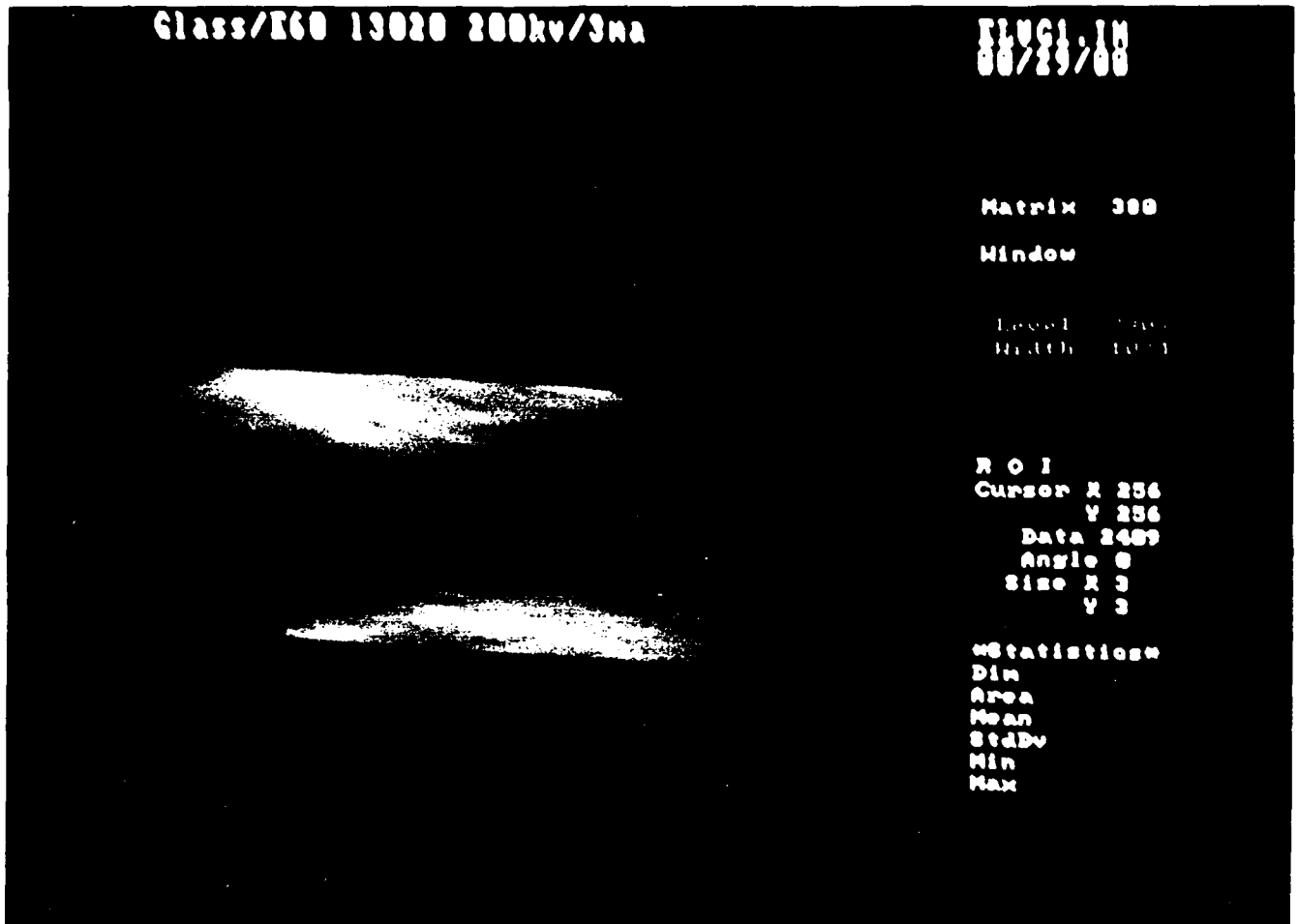

Figure 42. The Processing Code 60 limited view CT image is based on 40° of data taken parallel to the edge of the material. Many low density features are visible.

Summary of Pultrusion Evaluation

Pultrusion materials appear to be a prime candidate for analysis by limited view CT. Valuable information may be obtained from either the reconstructed image, or from the raw data. In either format, low density structures, which indicate the processing quality, can be identified. In this way,

limited view CT may be an important tool in process control. A 40° data set would appear to offer more than enough information for analysis of the process.

The 40° data set can be collected in a single object translation. Using a 0.020 msec integration time per 0.250 mm increment, we can scan 150 mm in 12 seconds. The pultrusion in continuous production is moving at either 2.5 mm/sec (6 inches/minute) or 1.25 mm/sec (3 inches/minute). CT slice position must be maintained during data collection.

This approach appears feasible, and a system to inspect the material as it is processed is proposed in Section 6.0 of this report. The system would not provide 100% inspection, but would be capable of imaging a slice every 12 seconds. This should be adequate for process control and also for sorting out bad material.

Density variation cannot be determined from DR images because the random distribution of fibers is the dominant feature in the data set. The normal or near normal x-ray beam does not provide the ability to characterize the cross-sectional density distribution.

6.0 CONCLUSIONS

- Limited view tomography is a CT technique that uses a small subset of the data normally collected for complete CT. The reconstruction of this data set does not provide a detailed picture of the cross-section, but in many applications it *does* provide enough information to characterize features and their position. It has the advantages that data collection is less time-consuming, and the mechanics are not as complex as required for full view CT. The limited view data sets acquired in this study were generally a 40° subset of the 180° required for full CT. This subset was selected because it is the largest set feasible without introducing mechanical complexity. Limited view technology has been successfully applied in the automotive industry for evaluating flaws in pistons, and other aluminum castings. It is a viable technique for the Army's pultrusion application, and possibly for the armor application.
- In the inspection of composite materials, computed tomography offers the greatest cross-sectional resolution, but is a time consuming technique and difficult to justify for most on-line applications. CT may have justification for the Army's pultrusion application.
- Digital radiography is the easiest method to implement for use in an on-line manufacturing environment, but images are subject to superpositioning. DR has a very fast data acquisition rate, allowing it to keep up with on-line production speeds. Also the inherent "in motion" characteristic of on-line manufacturing systems can often be used as the DR data collect motion. If it is possible to combine the function of the motion of the product through the production line, the cost of inspection can be reduced significantly.
- Dual energy subtraction is a technique that can be used to provide an atomic number map of materials rather than the normal density map obtained in CT and DR. This is useful in the analysis of composites when separation of features by density fails. The technique entails alternately or simultaneously sampling a high and low energy attenuation pattern of the material and creating a image based on the relationship between the two patterns. This can be a strong tool for on-line composite inspection in some applications. The dual energy data collected in this study did not exhibit promising results, and most likely cannot be used for the composites in this study.

6.1 Discussion

Each of the three materials evaluated in this Phase I SBIR program represents a unique and different challenge for cross-sectional analysis. For example, the armor, which is manufactured in large sheets and formed into hulls for vehicles, would be almost impossible to image using CT because of its final manufactured form. The helmets, on the other hand, are small parts that could be easily inspected with CT. The pultrusion samples have a unique problem: they are manufactured on-line and have continuous motion during the manufacturing an inspection process.

CT was able to characterize the cross-section of the armor and to provide a detailed presentation of the density variations. DR was capable of finding major defects in the material, but was unable to characterize the cross-section to any reasonable degree. LVT appears to offer real potential for inspection of the armor in its final manufactured form. Continuous, simultaneous movement of the x-ray tube and detector set parallel to the x-ray fan beam can provide a continuous limited view sinogram. This sinogram can be evaluated, or a convolution backprojection of the limited view data set can map features. The 40° fan beam was useful if little detail is required. A 90° fan beam can offer a

mapping with clear detail. Some detail is important in evaluating armor cross-sections, and the 90° fan beam data collect and convolution backprojection mappings appear to satisfy that need.

Small parts in general are possible candidates for full view CT. Four factors are important in the decision as to which technique is viable for inspection. Spatial and density resolution are the two image quality characteristics that are most important. Data collection and reconstruction time are also important criteria for the practical application of the technique in the production environment. The helmet in particular has both image quality and production constraints. It is difficult, if not impossible, to separate the individual layers in the cross-section of the helmet with full view CT, let alone a limited view representation. The helmet appears to be the most difficult application of the three samples and the least likely to yield to this technology.

The pultrusion product seems to be a likely candidate for either full view or limited view CT. DR cannot cope with the random variations in the glass fibers in the material. CT can easily characterize the cross-sections with a detailed analysis. LVT could actually meet most of the evaluation requirements for process control. Something as simple as a gross cross-sectional density measurement may be adequate, or a feature count may be required. Both, it appears, could be provided by a 40° limited view data collection and reconstruction. This type of inspection could keep up with the manufacturing rates and provide close to 100% inspection.

Of the three materials investigated, the pultrusion product appears to offer the most potential for LVT inspection. The pultrusion manufacturing method is continuous, which lend itself to the motion required for inspection. Product characterization and process control information would be immediately available. The likelihood of success is quite high in this application.

6.2 Proposed Inspection System Based on Phase I Results

A system that is capable of on-line limited view computed tomography of pultrusions will be proposed for Phase II. The proposed system will also be capable of full view CT of pultrusions and other small samples. Both of these techniques are necessary for a complete evaluation of the on-line capability of this inspection process.

The system proposed for Phase II is based on BIR's Radapt product line. A concept drawing is shown in Figure 43. The system consists of a standard Radapt computer console, a 160 kV x-ray source and controller, a manipulator, and a shielded cabinet. The standard computer console is capable of providing all of the control functions for data collection and reconstruction into CT images. The x-ray source is an industrial 160 kV system with a standard 40° fan beam x-ray tubehead. The x-ray tubehead and detector array are mounted on the manipulator, which provides the transverse motions necessary for limited view and full view CT data collection. The manipulator, tubehead, and detectors are housed in a shielded cabinet, which has openings for the pultrusion material to enter and leave.

The system is designed to be a part of the pultrusion manufacturing process. The continuously manufactured material would enter the x-ray shielded cabinet after manufacture and be inspected for proper cross-sectional characteristics. The results of the image evaluation would be fed back to the process control system for any required adjustments.

The proposed Radapt console is shown in Figure 44. It includes two displays: one is alphanumeric, operated by the keyboard to provide the control interface; the other is for image display. The image display has an image processing menu that is accessed using the mouse. The manipulator consists of a "C" arm, which translates the x-ray tube and detector array across the sample for single-pass data collection. The "C" arm also maintains CT slice position in the material as it translates. The gantry is capable of full view CT data collection by taking 180° data sets. Sample rotation is done by a rotating

On Line Cross-Sectional Material Evaluation System

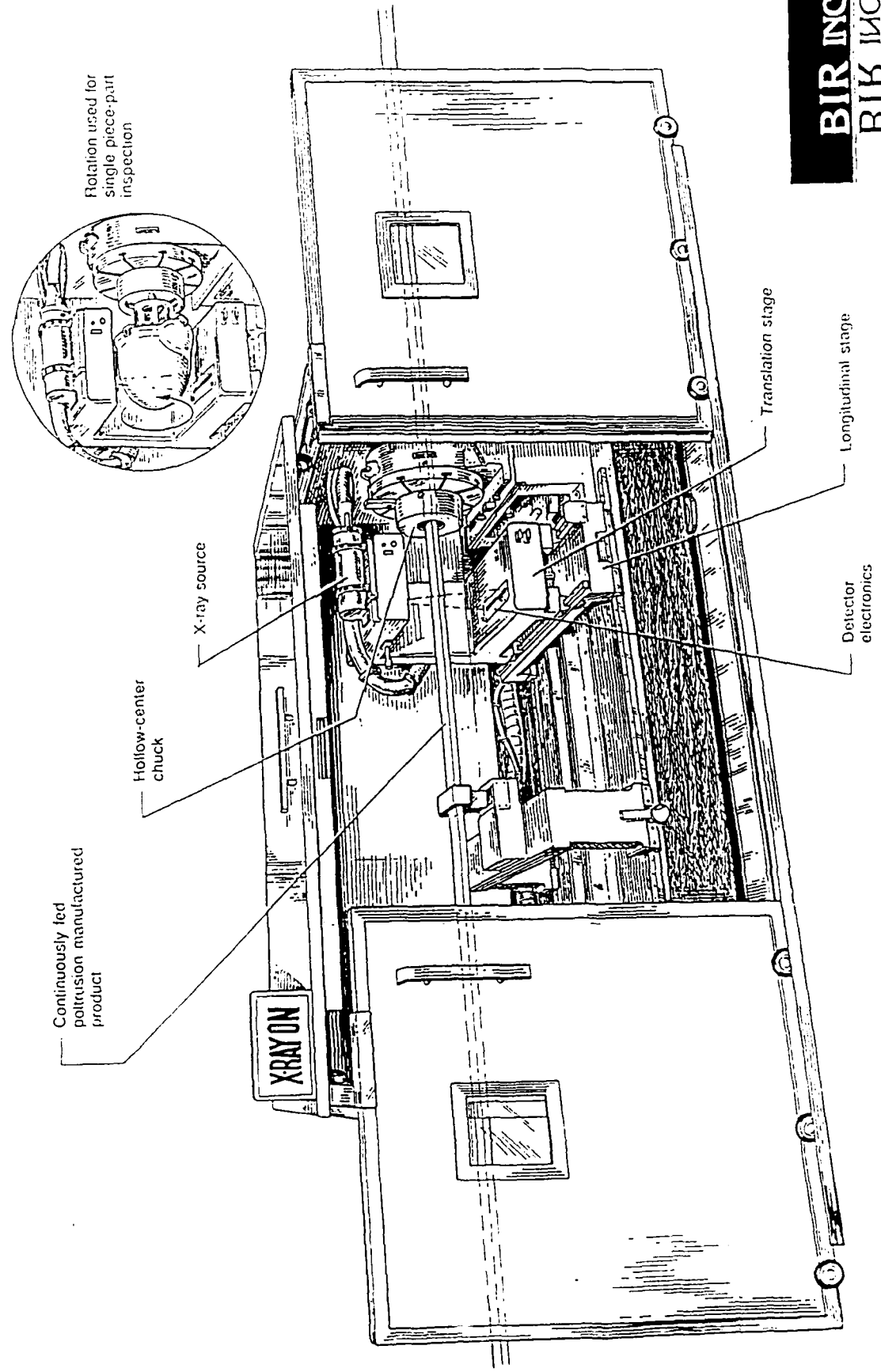

Figure 4.3. The concept for the proposed Phase II system is shown.

RADAPT CONTROL CONSOLE



The **RADAPT control console** is the primary user interface to all RADAPT systems. It controls and manages all system resources and provides communication with subsystems such as the data acquisition system (DAS). It consists of an alphanumeric monitor; an image monitor; a keyboard and mouse; data acquisition and control systems; storage devices; and a hardcopy output device.

The operator interfaces with the system using the keyboard and alphanumeric monitor. Pressing a function key calls up an interactive form that lets the operator vary system parameters. Pressing the execute key executes the function. In this way, the operator can create, retrieve, and store files; set scan parameters; initiate scanning, and process the image data.

The operator interfaces with the image monitor using the mouse and menu bar. Selecting an operation from the menu bar activates the operation. The operator can enhance edges and features of the image, measure areas and dimensions, generate statistics within regions of interest (ROIs), draw density profiles, or evaluate the gray level distribution in the image. The mouse also allows the operator to "window" the image — to select a portion of a wide range of data for display.

The RADAPT console is multitasking, allowing the operator to perform many operations simultaneously. For example, it is possible to view images during scanning or reconstruction. Such effective resource utilization means maximum system performance.

Figure 44. The control console for the proposed Phase II system is shown.

chuck. The rotating chuck can only be used with stationary materials.

The system proposed for Phase II is not the final configuration that would be most efficient for production processing. It is designed as a prototype with the capability for full view CT to allow complete evaluation of the technique. Once on-line feasibility is proven, the proposed system can be used in a laboratory environment as a CT research tool.

System Configuration for Radapt OL—X-Ray Inspection System for On-Line Evaluation

Advantages

- High-contrast cross-sectional video images with up to 100 times the contrast of conventional fluoroscopic systems.
- High-speed image reconstruction.
- Ability to see image details of low-density materials in a high-density environment.
- High-resolution image display system.
- Complete control over the displayed range of contrast.
- Ability to type alphanumeric notation on the images.
- Ability to mark circular, rectangular, or irregular regions of interest with overlaid boundaries.
- Ability to magnify the image in a given area of interest.
- Digital image storage on cassette tape, floppy disk, or hard disk.
- Relative density measurements at operator-specified points in the image.
- Relative dimensional measurements at operator-specified positions in the image.
- Histograms and line profiles of an area of interest.
- Mouse interface for user-friendly display control.
- Programmed inspection capability.

System Components

- solid-state detector array
- data acquisition system (DAS)
- computer system
- image processor
- manipulator
- 160 kV x-ray system
- control console
- shielded cabinet

System Performance

<i>Maximum Operating Envelope</i>	
length	1549 mm (61 inches)
diameter	175 mm (7.0 inches)
weight	159 kg (350 lb)
<i>Computed Tomography Performance</i>	
scan field diameter	175 mm (7.0 inches)
reconstruction and display field diameter	175 mm (7.0 inches)
spatial resolution cut-off at 100% contrast	5 line pairs/cm
scan times	90 seconds with minimum integration time; longer integration times may be selected
reconstruction time	90 seconds for a 256x256 matrix
imaging method	object translate-rotate
slice thickness	2 mm, 5 mm or 10 mm

Note: All specifications may not be available simultaneously.

Operator Functions

The fully integrated operator console permits the operator to select scan functions by means of a alphanumeric keyboard and video monitor. The image display functions are controlled from a menu by a mouse. Control functions include:

- manual CT scan programming and/or execution
- automated CT scan programming and/or execution
- image archive
- system calibration and test.

Image Display

Images are displayed on a 12 inch NTSC video monitor with 256 levels of gray and 2562 pixels. (The system will support 4002 pixels plus annotation.) Image window control is fully interactive with the window width and level continuously displayed. The window can be either linear or histogram equalized. Rectangular, circular, elliptical, or irregular regions of interest (ROIs) can be selected, and line profiles or histograms of the ROI can be generated. Within an ROI, the mean, range, standard deviation, and pixel position vs. value can be calculated. Zoom (2x) magnification is also available. The 12 inch alphanumeric display is 80 columns by 24 lines.

Data Storage

There are three formats for data storage available on Radapt OL:

- 80 Mbyte Winchester hard disk for operating programs
- 380 Mbyte hard drive for images
- 360 kbyte 5-1/4 inch floppy disk drive for programmed inspection procedures
- 40 Mbyte cartridge tape drive for storing up to 80 512x512 images.

Computer System and Control Console

The computer system is a standard Multibus configuration with 4.125 Mbytes of memory and a 32 bit CPU operating at 10 MHz. System interface is accomplished through an RS-232 serial port and an IEEE 488 parallel port. Overall size of the control console is 1882 x 1219 x 1016 mm (74 x 48 x 40 inches) with a weight of 50 kg.

Image Processor

- Standard Mercury Zip Array Processor with 640 kbytes of memory and a CPU capable of 10 million operations per second (MOPS). The operating system is contained on one 80 Mbyte 525 Winchester system disk, while all images are stored on the 380 Mbyte data disk. The standard image processor is housed in the control console base.
- Optional BIR High-Speed Parallel Image Processor with 32 Mbytes of memory and 200 MOPS operating speed and multiplanar display capability (*Note:* This system reduces the CT reconstruction time of the standard system by a factor of 20.) Image storage is on four 80 Mbyte hard disks. The optional high speed image processor is housed in a separate cabinet. Overall size is 750 x 750 x 1500 mm (30 inches x 30 X 60 inches) with a weight of 50 kg.

X-Ray System

The x-ray system can be controlled manually from the x-ray control panel or remotely from the Radapt operating console. A water-cooled heat exchanger is provided.

X-Ray System Specifications

Maximum Voltage:	160 kV
Maximum Current:	
(small spot)	4 mA
(large spot)	19 mA
Focal Spot Diameters:	3.0 mm and 0.4 mm DIN

X-Ray Shielded Cabinet

The shielded cabinet meets all DHHS requirements for radiation leakage. Two leaded glass windows are provided for viewing during scanning. The manipulator is housed in the cabinet and consists of a "C" arm and rotating chuck. The x-ray tubehead is also contained in the cabinet along with the detector array. Overall size is 1667 x 800 x 2032 mm with a weight of 2400 kg.

System Power Requirements

208 volts, 3 phase, 50 amps